



McIntosh Laboratory, Inc. 2 Chambers Street Binghamton, New York 13903-2699 Phone: 607-723-3512 www.mcintoshlabs.com

MC255

Power Amplifier

Owner's Manual





Important Safety Information is supplied in a separate document “Important Additional Operation Information Guide”

Thank You

Your decision to own this McIntosh MC255 Five Channel Power Amplifier ranks you at the very top among discriminating music listeners. You now have “The Best.” The McIntosh dedication to “Quality,” is assurance that you will receive many years of musical enjoyment from this unit.

Please take a short time to read the information in this manual. We want you to be as familiar as possible with all the features and functions of your new McIntosh.

Please Take A Moment

The serial number, purchase date and McIntosh Dealer name are important to you for possible insurance claim or future service. The spaces below have been provided for you to record that information:

Serial Number: _____

Purchase Date: _____

Dealer Name: _____

Technical Assistance

If at any time you have questions about your McIntosh product, contact your McIntosh Dealer who is familiar with your McIntosh equipment and any other brands that may be part of your system. If you or your Dealer wish additional help concerning a suspected problem, you can receive technical assistance for all McIntosh products at:

McIntosh Laboratory, Inc.
2 Chambers Street
Binghamton, New York 13903
Phone: 607-723-3512
Fax: 607-724-0549

Customer Service

If it is determined that your McIntosh product is in need of repair, you can return it to your Dealer. You can also return it to the McIntosh Laboratory Service Department. For assistance on factory repair return procedure, contact the McIntosh Service Department at:

McIntosh Laboratory, Inc.
2 Chambers Street
Binghamton, New York 13903
Phone: 607-723-3515
Fax: 607-723-1917

Table of Contents

Safety Instructions	2
(Separate Sheet)	Important Additional
	Operation Information Guide
Thank You and Please Take a Moment.....	2
Technical Assistance and Customer Service	2
Table of Contents	2
General Information	2
Connector and Cable Information	3
Introduction.....	3
Performance Features	3
Dimensions	4
Installation	5
Rear Panel Connections and Switch	6
Output Terminals and How to Connect	7-8
Connection Diagram (Separate Sheets)	Mc1A-2A
Front Panel Displays and Controls.....	10
How to Operate.....	11
Technical Description	12-15
Photos.....	16-17
Specifications.....	18
Packing Instruction.....	19

General Information

1. For additional connection information, refer to the owner’s manual(s) for any component(s) connected to the MC255.
2. The MC255 mutes the speaker output for approximately two seconds when first turned on.
3. For the best performance and safety it is important to always match the impedance of the Loudspeaker to the Power Amplifier connections. Refer to “How to Connect” pages 7 and 8.

Note: The impedance of a Loudspeaker actually varies as the Loudspeaker reproduces different frequencies. As a result, the nominal impedance rating of the Loudspeaker (usually measured at a midrange frequency) might not always agree with the impedance of the Loudspeaker at low frequencies where the greatest amount of power is required. Contact the Loudspeaker Manufacturer for additional information about the actual impedance of the Loudspeaker before connecting it to the McIntosh MC255.

4. In the event the MC255 over heats, due to improper ventilation and/or high ambient temperature, the protection circuits will activate. The Front Panel Power Guard LED will continuously indicate ON and the audio will be muted. When the MC255 has returned to a safe operating temperature, normal operation will resume.
5. When discarding the unit, comply with local rules or regulations. Batteries should never be thrown away or incinerated but disposed of in accordance with the local regulations concerning battery disposal.
6. For additional information on the MC255 and other McIntosh Products please visit the McIntosh Website at www.mcintoshlabs.com.



Connector and Cable Information

XLR Connectors

Below is the Pin configuration for the XLR Balanced Input, Input/Output Connectors on the MC255. Refer to the diagram for connection:

- PIN 1: Shield/Ground
- PIN 2: + Input/Output
- PIN 3: - Input/Output

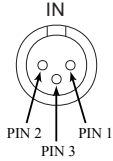

Power Control Connector

The MC255 Power Control Input receives an On/Off signal from +5 to +12 volts. The Power Control Output will in turn provide a +12 volt Output Signal with a total current up to 50mA. An additional connection is for controlling the illumination of the MC255 Power Output Meters. The 1/8 inch stereo mini phone plug connects to a McIntosh Preamplifier or A/V Control Center Power Control Output.

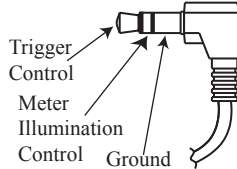

Output Terminal Connector

When cables with spade lugs are used for Loudspeaker Connection, the spade lugs need an opening of at least 3/10 inch (7.6mm).

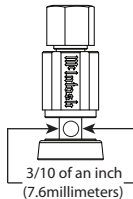

Introduction

Now you can take advantage of traditional McIntosh standards of excellence in the MC255 Power Amplifier. This Five Channel Power Amplifier with high current output will drive any pair of high quality Loudspeakers. The MC255 reproduction is sonically transparent and absolutely accurate. The McIntosh Sound is “The Sound of the Music Itself.”

Performance Features

• Power Output

The MC255 is a Five Channel Home Theater Power Amplifier with a capability of 250 watts from the Front Three Channels (Left, Center and Right) and 200 watts from the Surround Channels (Left and Right) into 4 or 8 ohm speakers with less than 0.005% distortion. The Power Amplifier Circuitry uses ThermalTrak¹ Output Transistors for lower distortion and cool operation.

• Balanced and Unbalanced Inputs

Balanced connections guard against induced noise and allow long cable runs without compromising sound quality.

• Power Guard

The patented McIntosh Power Guard circuit prevents the amplifier from being over driven into clipping, with its harsh distorted sound that can also damage your valuable loudspeakers.

• Zone B Operation

The Zone B on the MC255 provides Two Channel Music Playback in a second room with 200 watts per channel, while at the same time Zone A provides Three Channel Home Theater Playback.

• Sentry Monitor and Thermal Protection

McIntosh Sentry Monitor power output stage protection circuits ensure the MC255 will have a long and trouble free operating life. Built-in Thermal Protection Circuits guard against overheating.

• Special Power Supply

A very large Power Transformer and Large Capacitors ensure stable noise free operation even though the power line varies.

• Illuminated Power Meters

The Illuminated Power Output Watt Meters on the MC255 are peak responding, and indicate the true power output of the amplifier. The Front Panel Meter Illumination may be switched Off at any time.

• McIntosh Custom Binding Posts

McIntosh patent pending gold plated output terminals deliver high current output. They accept large diameter wire and spade lugs. Banana plugs may also be used only in the United States and Canada.

• Glass Front Panel and Super Mirror Chassis Finish

The famous McIntosh Illuminated Glass Front Panel uses long life Light Emitting Diodes (LEDs) and the Stainless Steel Chassis with Super Mirror Finish ensures the pristine beauty of the MC255 will be retained for many years.

¹ ThermalTrak™ and ON Semiconductor are trademarks of Semiconductor Components Industries, LLC

Dimensions

The following dimensions can assist in determining the best location for your MC255.

Front View of the MC255

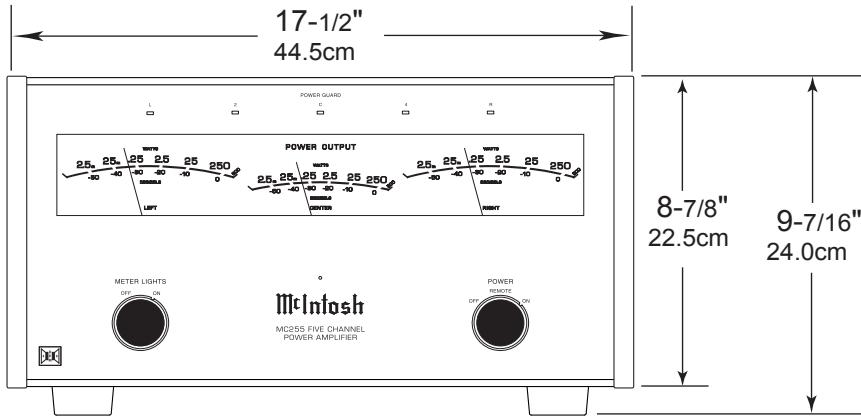

Rear View of the MC255

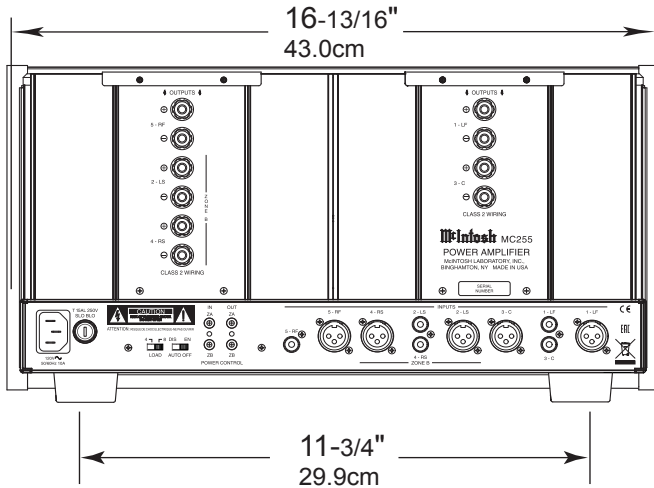

Side View of the MC255

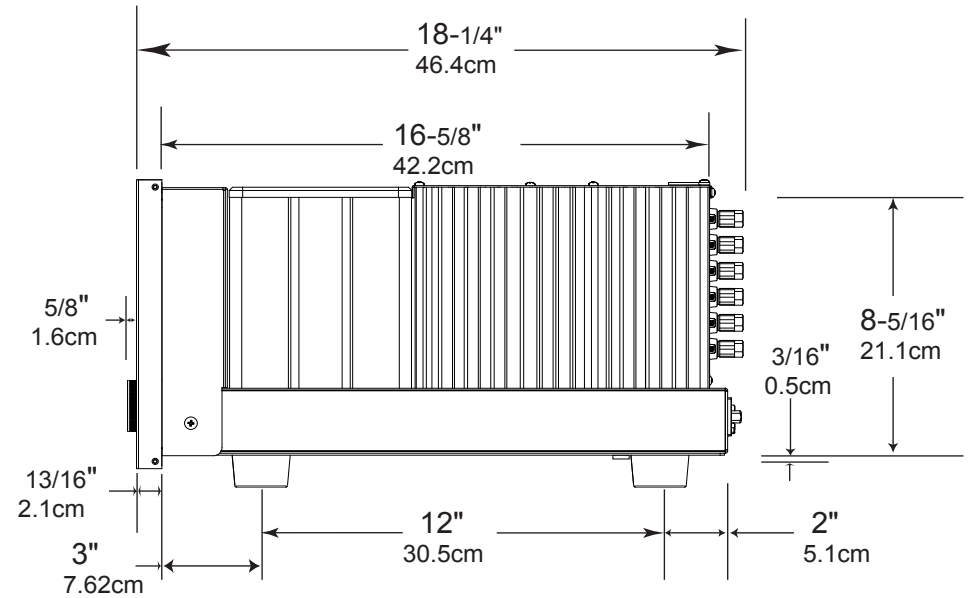

Installation

The MC255 can be placed upright on a table or shelf, standing on its four feet. It also can be custom installed in a piece of furniture or cabinet of your choice. The four feet may be removed from the bottom of the MC255 when it is custom installed as outlined below. The four feet together with the mounting screws should be retained for possible future use if the MC255 is removed from the custom installation and used free standing. The required panel cutout, ventilation cutout and unit dimensions are shown.

Always provide adequate ventilation for your MC255. Cool operation ensures the longest possible operating life for any electronic instrument. Do not install the MC255 directly above a heat generating component such as a high powered amplifier. If all the components are installed in a single cabinet, a quiet running ventilation fan can be a definite asset in maintaining all the system components at the coolest possible operating temperature.

A custom cabinet installation should provide the following minimum spacing dimensions for cool operation.

Allow at least 6 inches (15.24cm) above the top, 2 inches (5.08cm) below the bottom, 3 inches (7.62cm) behind the rear panel and 2 inches (5.08cm) on each side of the Power Amplifier, so that airflow is not obstructed. Allow 7/8 inch (2.22cm) in front of the mounting¹ panel for clearance. **Be sure to cut out a ventilation hole in the mounting shelf according to the dimensions in the drawing.**

¹ When the MC255 is installed together with other McIntosh Components, check clearances on all components before proceeding.

MC255 Front Panel
Custom Cabinet Cutout

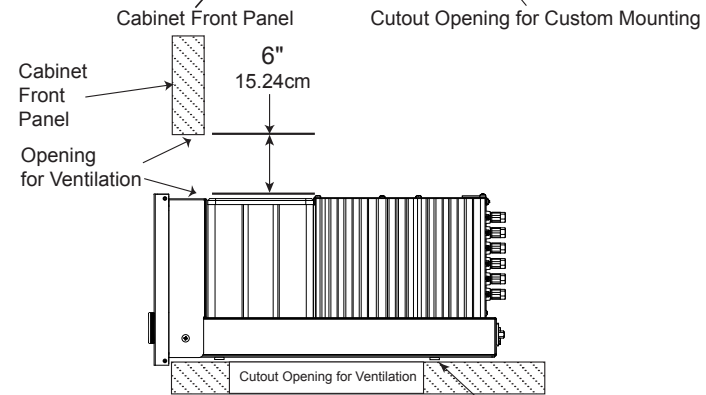
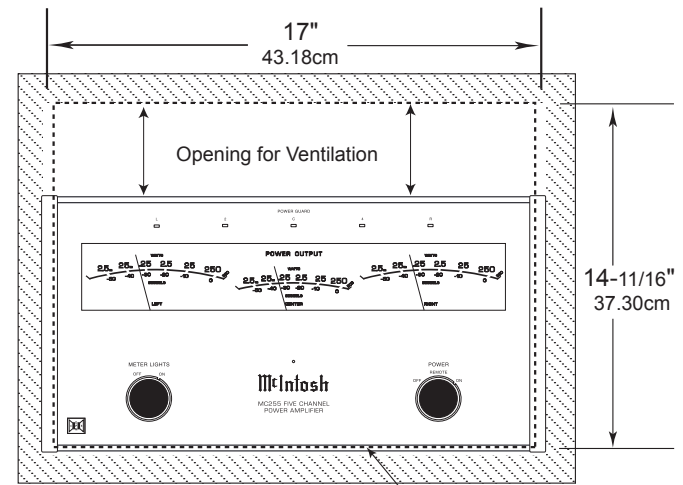

MC255 Side View
in Custom Cabinet

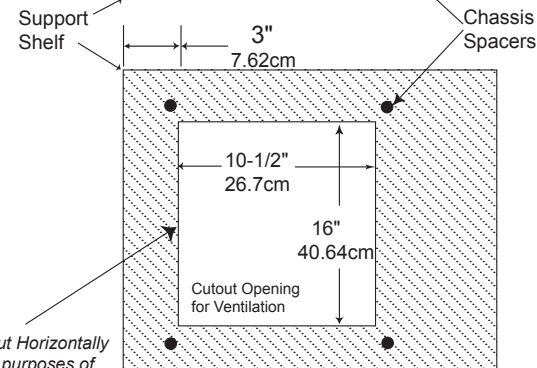

MC255 Bottom View
in Custom Cabinet

Note: Center the cutout Horizontally on the unit. For purposes of clarity, the above illustration is not drawn to scale.



Rear Panel Connections and Switch

OUTPUTS 5 Connections for Right Front Channel and for an 8 ohm or 4 ohm Loudspeaker

OUTPUTS 2 Connections (ZONE B) for Left Surround Channel and for an 8 ohm or 4 ohm Loudspeaker

OUTPUTS 4 Connections (ZONE B) for Right Channel Surround for an 8 ohm or 4 ohm Loudspeaker

Fuse holder, refer to the nomenclature next to the fuse holder to determine the correct fuse size and rating

Connect the MC255 power cord to a live AC outlet. Refer to information on the back panel of your MC255 to determine the correct voltage for your unit

POWER CONTROL IN ZA (Zone A) receives a turn On/Off signal from a McIntosh component for all five channels

POWER CONTROL OUT ZA (Zone A) sends a turn On/Off signal to the next McIntosh Component

OUTPUTS 1 Connections for Left Front Channel and for an 8 ohm or 4 ohm Loudspeaker

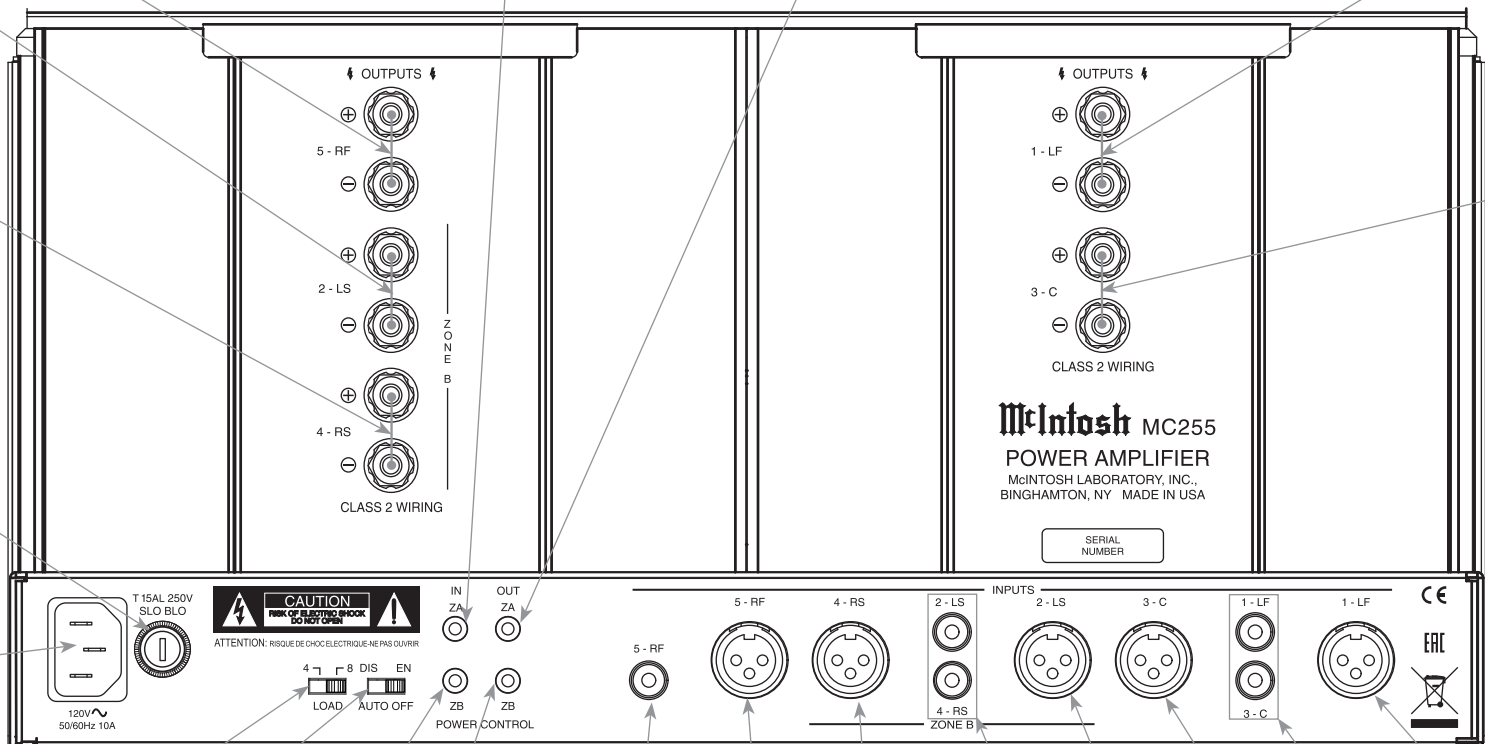

OUTPUTS 3 Connections for Center Channel and for an 8 ohm or 4 ohm Loudspeaker

Connect the MC255 power cord to a live AC outlet. Refer to information on the back panel of your MC255 to determine the correct voltage for your unit

Sets the impedance of the Connected Loudspeakers

POWER CONTROL IN ZB (Zone B) receives a turn On/Off signal from a McIntosh component for the LS and RS two channels

INPUT 5 Unbalanced Connection for the Right Front Channel

INPUT 4 Balanced Connection for the Right Surround Channel

INPUT 2 Balanced Connection for the Left Surround Channel

INPUTS 1 & 3 Unbalanced Connection for the Left Front and Center Channels

The Power Auto Off Feature is either ENable or DISable

POWER CONTROL OUT ZB (Zone B) sends a turn On/Off signal to the next McIntosh Component

INPUT 5 Balanced Connection for the Right Front Channel

INPUTS 2 & 4 Unbalanced Connection for the Left and Right Surround Channels

INPUT 3 Balanced Connection for the Center Channel

INPUT 1 Balanced Connection for the Left Front Channel

Output Terminals

When connecting the Loudspeaker Hookup Cables to the MC255 Power Amplifier Output Terminals please follow the steps below:

1. Rotate the top of the Output Terminal Post counterclockwise until an opening appears. Refer to figures A and B.
2. Insert the Loudspeaker hookup cable into the Output Terminal Post opening or the cable spade lug around the center post of the Output Terminal. Refer to figure C.
3. Rotate the top of the Output Terminal Post clockwise until it is finger tight. Refer to figure D.
4. Place the supplied McIntosh Wrench over the top of the Output Terminal and rotate it one quarter of a turn (90°) to secure the Loudspeaker Cable Connection. **Do not over tighten.** Refer to figure E.

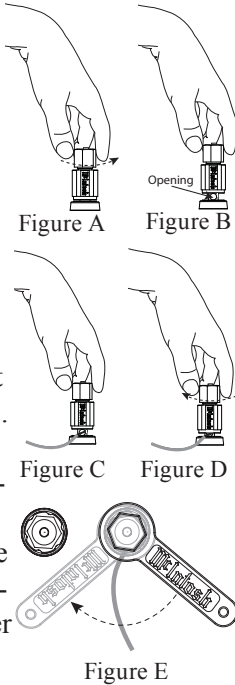

cable from the Audio Preamplifier or A/V Control Center Power Control (Trigger) Output 1 to the MC255 POWER CONTROL ZA INPUT.

2. For Zone B Operation, connect a power control cable from the Audio Preamplifier or A/V Control Center Power Control (Trigger) Output 2 to the MC255 POWER CONTROL ZB INPUT.

*Notes: 1. When a Power Control Cable is connected between the MC255 and a Preamplifier (or A/V Control Center), the AUTO OFF Feature is bypassed. Refer to page 11.
2. When a Subwoofer Loudspeakers is being used together with the MC255, connect a Power Control Cable from the MC255 POWER CONTROL Output ZA to the Power Control Input on the Subwoofer Loudspeaker.*

3. The MC255 has connections for Balanced Audio XLR Connection Cables that come from the connections on the Audio Preamplifier or A/V Control Center. Refer to the Connections on the separate folded sheets “Mc1A and Mc2A”. UnBalanced Audio Cables can be used instead of the Balanced XLR cables.

The MC255 Power Amplifier is designed for Loudspeakers with an impedance of 4 ohms or 8 ohms. Connect a single Loudspeaker to each of the Output Terminals.

When connecting Loudspeakers to the MC255 it is very important to use cables of adequate size, so there is little to no power loss in the cables. The size is specified in Gauge Numbers or AWG (American Wire Gauge). The smaller the Gauge number, the larger the wire size:

Loudspeaker Cable Distance vs Wire Gauge Guide			
Loudspeaker Impedance	25 feet (7.62 meters) or less	50 feet (15.24 meters) or less	100 feet (30.48 meters) or less
4 Ohms	14AWG	12AWG	10AWG
8 Ohms	16AWG	14AWG	12AWG

4. Prepare the Loudspeaker Hookup Cable for attachment to the MC255 Power Amplifier:

Bare wire cable ends:

Carefully remove sufficient insulation from the cable ends, refer to figures 2, 3 & 4. If the cable is stranded, carefully twist the strands together as tightly as possible.

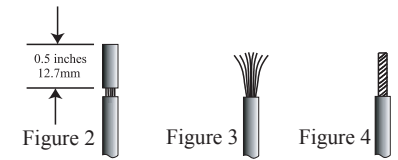

*Notes: 1. If desired, the twisted ends can be tinned with solder to keep the strands together.
2. The prepared bare wire cable ends may be inserted into spade lug connectors.
3. Banana plugs are for use in the United States and Canada only.*

Banana Plugs are for use in the United States and Canada only:

5. Attach the previously prepared bare wire cable ends into the banana plugs and secure the connections. Refer to figure F.

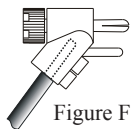

6. Rotate the top of the Output Terminal Post clockwise until it is finger tight. Refer to figure G. Then using the McIntosh Wrench, rotate the top of the Output Terminal one quarter of a turn (90°). **Do not over tighten.** Refer to figure E.

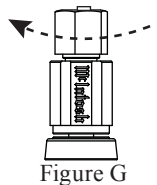

How to Connect

Caution: Do not connect the AC Power Cord to the MC255 Rear Panel until after the Loudspeaker Connections are made. Failure to observe this could result in Electric Shock.

The connection instructions below, together with the MC255 Connection Diagram located on the separate folded sheets “Mc1A and Mc2A”, are examples of a typical audio systems. Your system may vary from this, however the actual components would be connected in a similar manner. For additional information refer to “Connector and Cable Information” on page 3.

1. For Zone A Operation, connect a power control

- Referring to figure H, connect the Loudspeaker hookup cables with banana plugs into the MC255 hole at the top of the terminal to the \ominus Negative Output Terminal and the \oplus Positive Output Terminal identified as 4Ω (ohm) or 8Ω (ohm) connection to match the impedance of the Loudspeaker, being careful to observe the correct polarities. Place the LOAD Switch on the rear panel of the MC255 to either the 4 or 8 Ohm Setting, to match the impedance of the majority of the loudspeakers connected. If the Loudspeaker's impedance is in-between the available connections, use the nearest lower impedance connection. Refer to "General Information" Note 3 on page 2 for additional information.

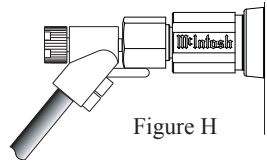

Figure H

WARNING: Loudspeaker terminals are hazardous live and present a risk of electric shock. For additional instruction on making Loudspeaker Connections contact your McIntosh Dealer or McIntosh Technical Support.

- Connect the MC255 power cord to an active AC outlet.

Spade Lug or Wire Connections:

- Connect the Loudspeaker hookup cables to the MC255 COM (Negative) Output Terminal and Positive Output Terminal identified as 4Ω (ohm) or 8Ω (ohm) connection to match the impedance of the Loudspeaker, being careful to observe the correct polarities. Insert the spade lug connector or prepared section of the cable end into the terminal side access hole, and tighten the terminal cap until the cable is firmly clamped into the terminals so

the lugs or wire cannot slip out. Refer to figures 7 and 8.

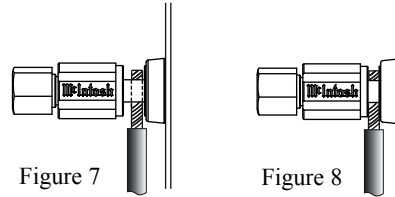

Figure 7

Figure 8

If the Loudspeaker's impedance is in-between the available connections, use the nearest lower impedance connection. Refer to "General Information" Note 3 on page 2 for additional information.

WARNING: Loudspeaker terminals are hazardous live and present a risk of electric shock. For additional instruction on making Loudspeaker Connections contact your McIntosh Dealer or McIntosh Technical Support.

- Connect the MC255 power cord to an active AC outlet.

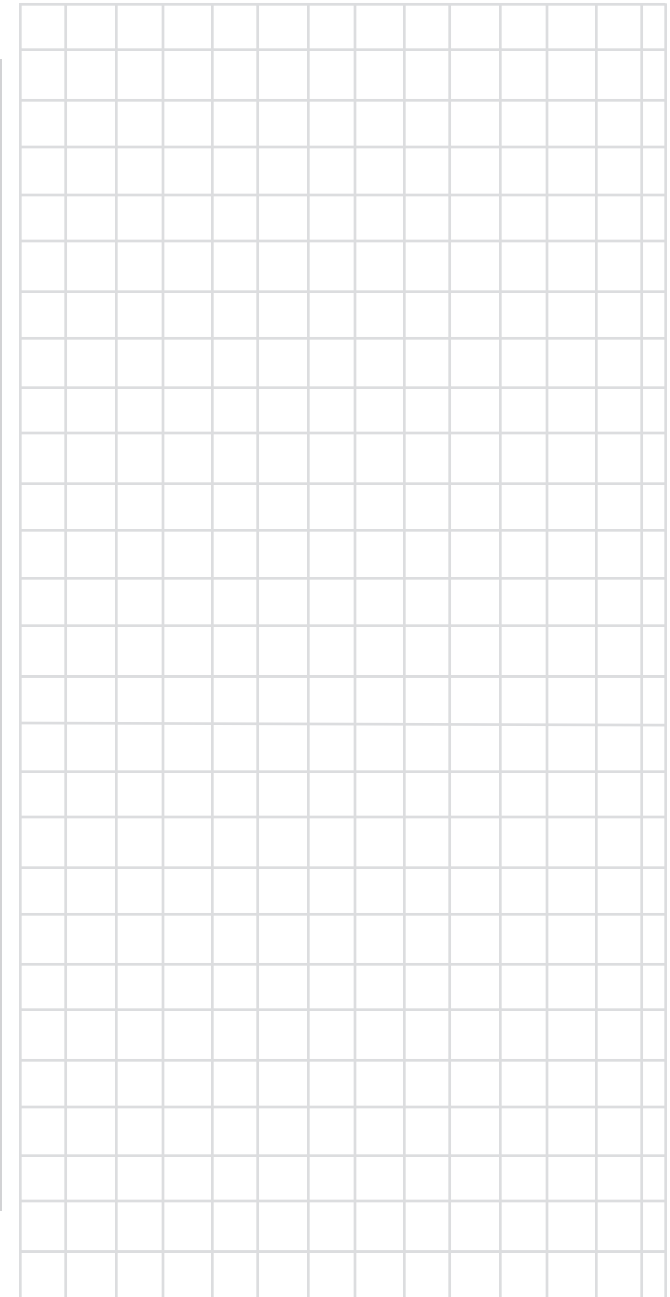

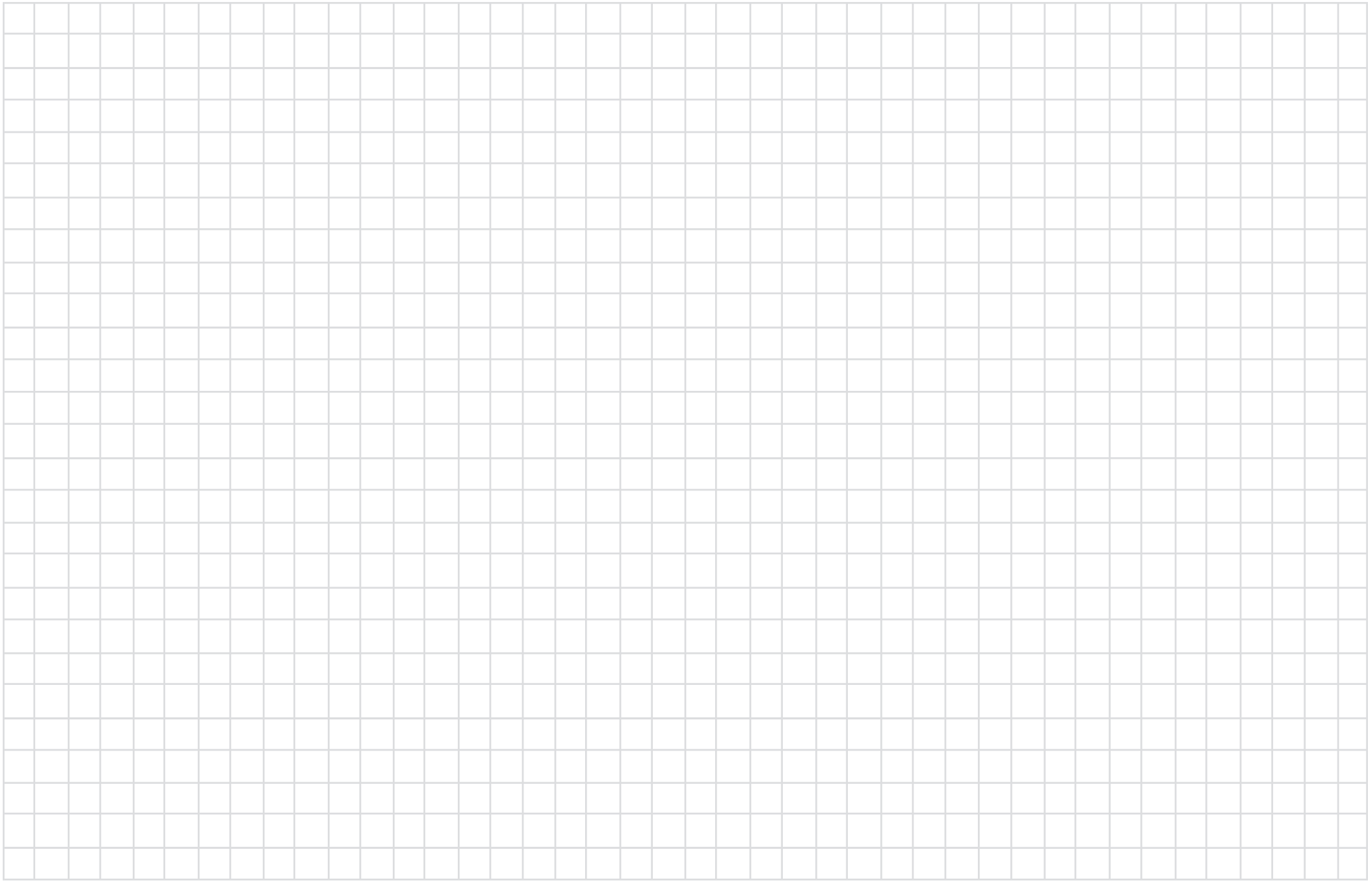



Meter indicates the Front Left Channel Output of the amplifier

Meter indicates the Front Center Channel Output of the amplifier

The LED indicates when the POWER GUARD Circuitry has activated for the Amplifier Center Channel (C4)

Meter indicates the Front Right Channel Output of the amplifier

The LEDs indicate when the POWER GUARD Circuitry has activated for Amplifier Channels, Left Front (LF1) and Left Surround (LS2)

The LEDs indicate when the POWER GUARD Circuitry has activated for Amplifier Channels, Right Front (RF5) and Right Surround (RS4)

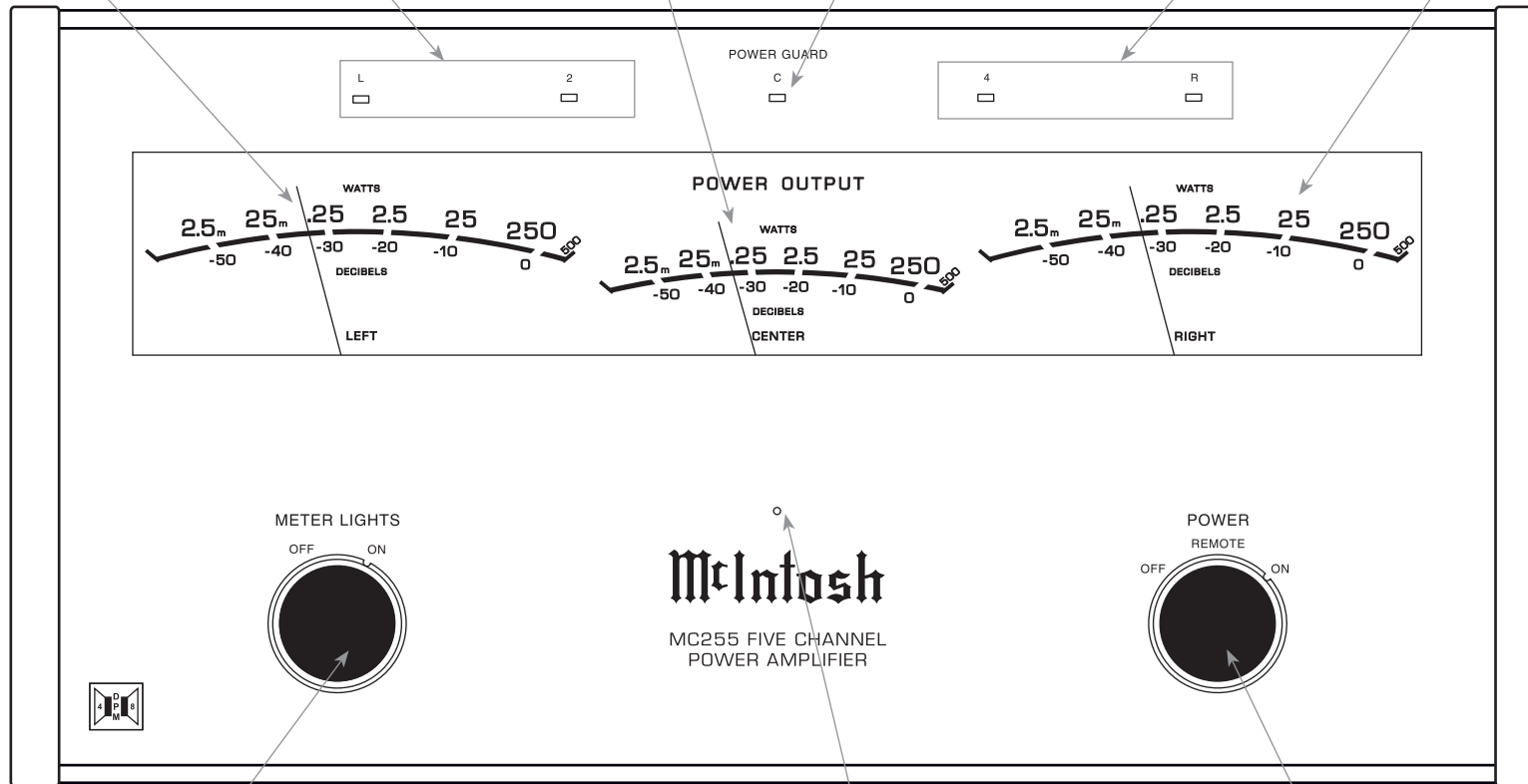

METER LIGHTS Switch on the Illumination of the Left, Center, Right Channel Meter Display

Standby Power On Indicator

POWER Switch Turns AC Power Off, Remote, AC Power On

How to Operate

Power On

There are two ways to have AC Power switched ON to the MC255:

REMOTE Setting

When the MC255 Power Control Connection (ZA and/or ZB) receives a Power Control Signal from a Preamplifier or A/V Control Center, it will turn On automatically when the MC255 POWER Control is set to the REMOTE Setting. Refer to figure 9.

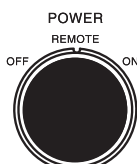

Figure 9

ON Setting

When the MC255 POWER Control is set to the ON position, it will become active Zone A only. Refer to figure 10. To switch the MC255 OFF, place the POWER Control in the OFF position.

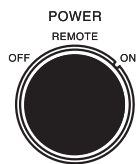

Figure 10

MC255 Channel Operation

There are two Channel Operation Modes. The first operation mode is referred to as Zone A. This occurs when the POWER Control is positioned to ON or set to the REMOTE position and is receiving a Power Control Signal in the ZA connector. When the MC255 is in the Zone A operation mode, the following is a list of Channel Operations:

MC255 ZONE A CHANNEL OPERATION	
Channel Number	Channel Function
1	Left Front
2	Left Surround
3	Center (Front)
4	Right Surround
5	Right Front

The other operation mode is referred to as Zone A/B when the POWER Control is in the REMOTE posi-

tion and both the ZA and ZB connectors are receiving Power Control Signals.

MC255 ZONE A and ZONE B OPERATION		
Zone	Channel Number	Channel Function
A	1	Left Front
A	3	Center (Front)
A	5	Right Front
B	2	Left
B	4	Right

Meters

Rotate the METER LIGHTS Switch to the ON position to illuminate the three Front Panel Meters for the Left, Center and Right Channels. Refer to figure 11.

Lights Off - Meter lights are turned off, the Meters will continue to indicate the power output.

Note: When Power Control Input of the MC255 is connected to an Audio Preamplifier or A/V Control Center with Remote Meter Illumination Control, the Meter Illumination will automatically be remotely controlled (On/Off).



Figure 11

Watts- The meters respond to all the musical information being produced by the amplifier. They indicate to an accuracy of at least 95% of the power output with only a single cycle of a 2000Hz tone burst. Refer to figure 12.

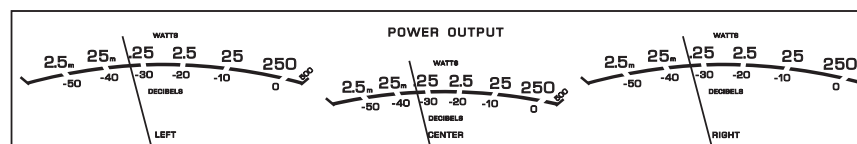

Figure 12

Auto Off Switch

The MC255 incorporates Power Save Circuitry to automatically place the MC255 into the power saving Standby Mode approximately 30 minutes after there has been an absence of an audio input signal.

When there is a Power Control Connection between the MC255 and a Preamplifier or A/V Control Center with Power Save Circuitry, the AUTO OFF Switch in the ENable position is bypassed (located on the Rear Panel of the MC255). Refer to figure 13.



Figure 13

In the event there is no Power Control Connection and the Power Save Circuitry is activating inappropriately relative to your specific use of the MC255, place the AUTO OFF Switch in the DISable position.

Note: If the Power Save Circuitry has switched Power to the MC255 OFF, place the POWER in the OFF Position and then in the ON position to reset the circuitry.

Load Switch

Place the Load Impedance Switch to the 4 Ohms position if the Loudspeakers Connected to the MC255 are not 8 Ohms but 4 Ohms. Refer to figure 14.

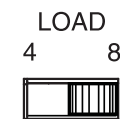

Figure 14



Technical Description

McIntosh Laboratory, the company who introduced the world's first amplifier that could be called "High Fidelity", has done it again. The McIntosh engineering staff has created a Power Amplifier without compromise, using the most advanced McIntosh circuit design concepts.

The MC255 has a continuous average power output rating of 250 watts and with a peak output current of 25 amperes per channel; making this one of the most advanced amplifiers available today. The distortion limits for the MC255 are no more than 0.005% at rated power output for all frequencies from 20Hz to 20,000Hz. Typical performance at mid frequencies is less than 0.002%. The true distortion readings on the MC255 are so low, it takes special measuring techniques to make accurate readings. The MC255 can deliver the best possible performance from any type of high quality loudspeaker system. Refer to figure 15.

Creating an amplifier with this level of performance did not come easily. Many months of design, testing and measuring were required. Extensive controlled listening tests, the ultimate form of measuring, were made before the final design was accepted.

Design Philosophy

The design philosophy incorporated in the MC255 involved several different techniques, all based on sound scientific logic. Every stage of voltage or current amplification must be as linear as possible prior to the use of negative feedback. McIntosh engineers know how to properly design negative feedback circuits so they contribute to the extremely low distortion performance expected from a McIntosh amplifier. The typical McIntosh owner would never accept the approximately 100 times higher distortion of many non-feedback designs. Refer to figure 16.

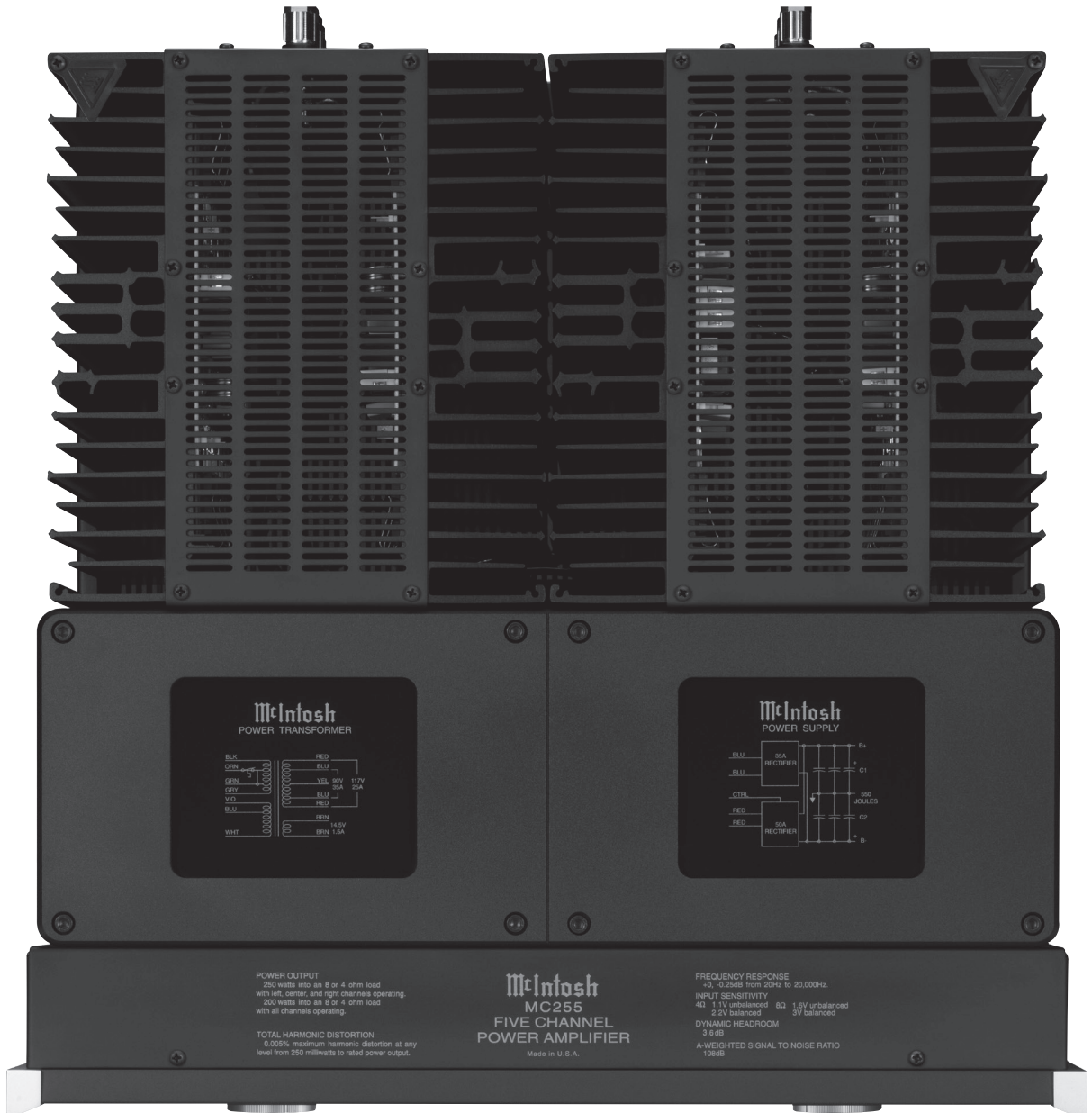

Figure 15

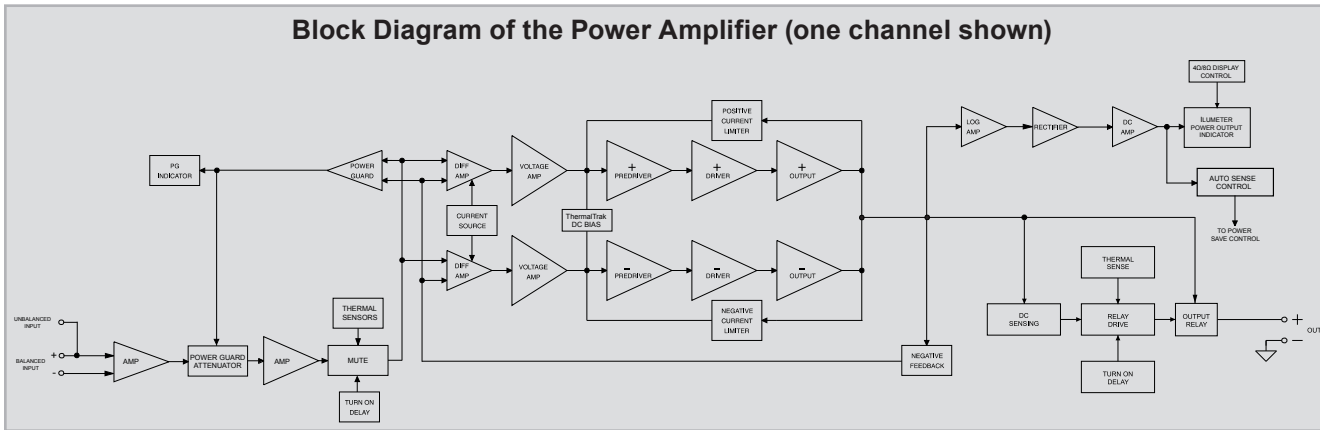

Figure 16

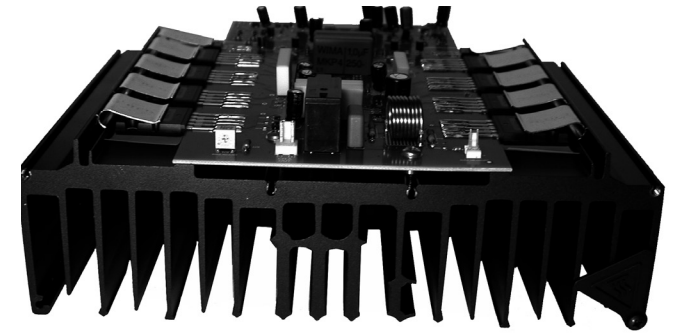

Figure 18

All transistors are selected to have nearly constant current gain over the entire current range they must cover. Output transistors in particular, have matched uniform current gain, high current bandwidth product and large active region safe operating area. These Power Transistors are the very latest in semiconductor technology and incorporate a new design known as ThermalTrak™. Refer to figure 17. This allows for the instantaneous and accurate monitoring of the Power Transistor Temperature. The MC255 Power Output

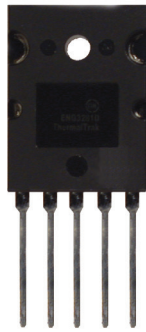

Figure 17

Circuitry has a specially designed bias circuit to take full advantage of the ThermalTrak™ Power Transistors and thus precisely controls the power amplifier operation over a wide range of music conditions with the benefits of lower distortion and cooler operation. Precision metal film resistors and low dielectric absorption film capacitors are used in all critical circuit locations.

The high efficiency circuit design of the MC255 contributes to low operating temperatures. More than 2800 square inches of heat sink area keep the MC255 operating safely with convection cooling. No fans are needed. Refer to figure 18.

Power Output Meter

The McIntosh MC255 has a large three Meter Wattage Output Meter that responds 95% full scale to a single cycle tone burst at 2kHz. Refer to figure 19. Voltage and current outputs are electronically measured, multiplied and fed to a special circuit that accelerates the pointer movement in the upward direction. When the pointer reaches its peak it pauses only long enough for the human eye to perceive its position, then drops. It is almost 10 times faster than a professional VU meter.

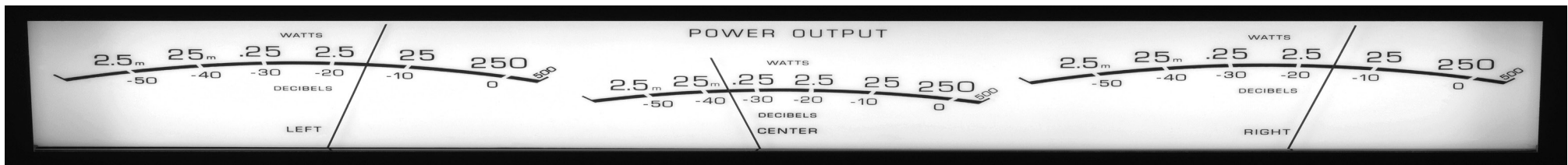

Figure 19

Technical Description, con't

Protection Circuits

The MC255 incorporates the McIntosh Sentry Monitor Output Transistor Protection Circuit. Refer to Figure 20. There is absolutely no compromise in sonic performance with this circuit, and it ensures safe operation of the amplifier under even the most extreme operating conditions. The different

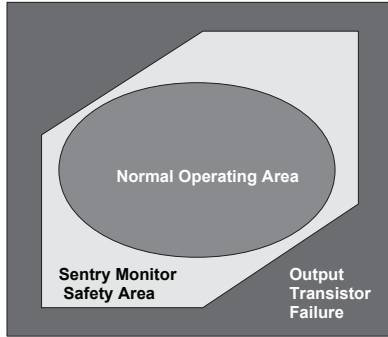

Figure 20

types of protection circuits incorporated in the MC255 insure a long and safe operating life. This is just one of the many characteristics of McIntosh Power Amplifiers that make them world famous.

The MC255 also includes the unique patented McIntosh Power Guard circuit. Power Guard eliminates the possibility of ever overdriving the amplifier into clipping. Refer to figures 21, 22 and 23. An overdriven amplifier can produce both audible and inaudible distortion levels exceeding 40%.

The audible distortion is unpleasant to hear, but the inaudible ultrasonic distortion is also undesirable, since it can damage valuable loudspeaker system tweeters. You will never experience the harsh and damaging distortion due to clipping.

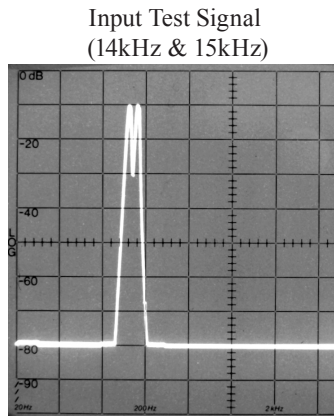

Figure 21

The Power Guard circuit is a waveform comparator, monitoring both the input and output waveforms. Under normal operating conditions, there are no differences between the shape of these waveforms. If the amplifier is overdriven, there will be a difference between the two signal waveforms. When the difference exceeds 0.3%, the Power Guard activates the PG light and a dynamic electronic attenuator at the amplifier input reduces the input volume just enough to prevent any further increase in distortion. The Power Guard circuit acts so fast that there are absolutely no audible side effects and the sonic purity of the music reproduction is perfectly preserved. The MC255 Power Amplifier with Power Guard is not limited to just the rated power output, but will actually produce distortion free output well above its rated power due to the McIntosh philosophy of conservative design.

Without Power Guard

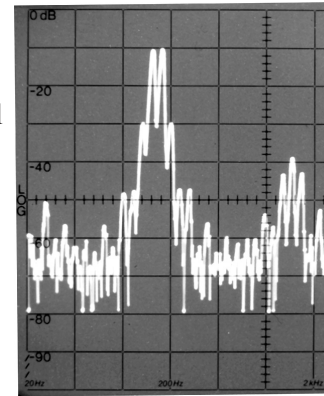

Figure 22

With Power Guard

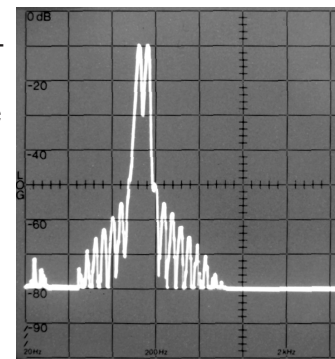

Figure 23

Power Supply Circuits

To compliment the design of the MC255 Power Amplifier Circuitry, there is a high current high voltage power supply. Refer to figures 24 and 27.

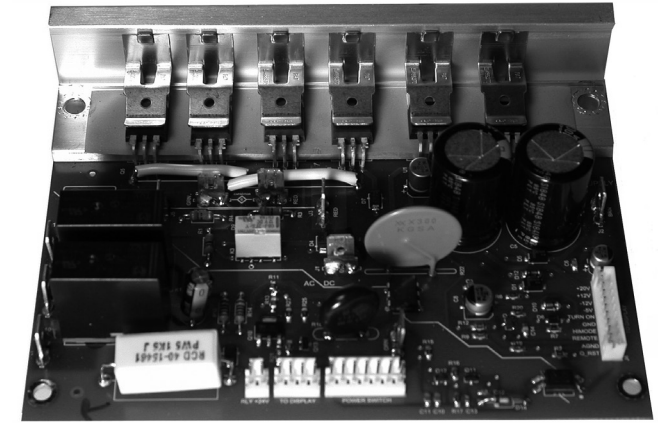

Figure 27

The very large Power Transformer can supply over 13 amps of current. Refer to figure 25 (golf ball is for size comparison).



Figure 25

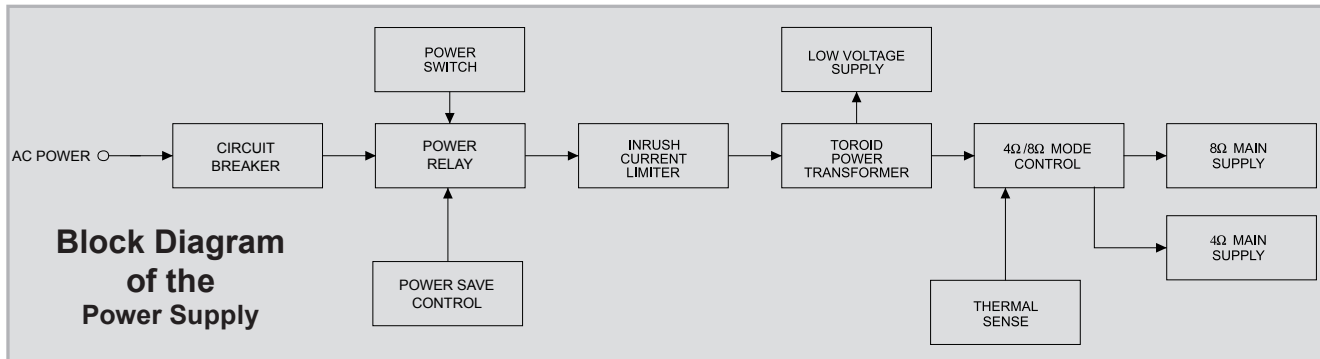

Figure 24

It is enclosed in the legendary McIntosh Potted Enclosures and weighs 30 lbs. The six super size main filter capacitors can store over 350 Joules of energy which is necessary for the wide dynamic range that “Digital Audio” demands. Refer to figure 26.



Figure 26

The power amplifier draws high current from the AC power line. Therefore, it is important that they plug directly into the wall outlet.

Also, most owners desire one power switch for the whole audio system. The MC255 is equipped with a circuit that provides remote Power Control from a McIntosh A/V Control Center. When the A/V Control Center is switched On, a (+5V) signal operates the power relay in the MC255. The MC255 also has two remote Power Control Out Jacks. The Power Control signal from these jacks is delayed by a fraction of a second so that the turn on power surge of the next power amplifier occurs at a later time. This helps prevent power circuit overload that could trip circuit breakers or blow fuses, a very important feature in high power Home Systems employing multiple MC255 Power Amplifiers.









Specifications

Power Output (All Five Channels)

Minimum sine wave continuous average power output per channel, all channels operating is:
200 watts into a 4 ohm or 8 ohm load

Power Output (Three Front Channels)

Minimum sine wave continuous average power output per channel operating is:
250 watts into a 4 ohm or 8 ohm load

Output Load Impedance

8 and 4 ohms

Rated Power Band

20Hz to 20,000Hz

Total Harmonic Distortion

0.005% maximum harmonic distortion at any power level from 250 milliwatts to rated power, 20Hz to 20,000Hz

Dynamic Headroom

3.6dB

Frequency Response

+0, -0.25dB from 20Hz to 20,000Hz
+0, -3dB from 10Hz to 100,000Hz

Input Sensitivity (for rated output)

2.2 Volt Balanced with a 4 ohm Loudspeaker
1.1 Volt Unbalanced with a 4 ohm Loudspeaker
3.0 Volt Balanced with an 8 ohm Loudspeaker
1.6 Volt Unbalanced with an 8 ohm Loudspeaker

Signal To Noise Ratio (A-Weighted)

108dB below rated output

Intermodulation Distortion

0.005% maximum, if the instantaneous peak power output does not exceed twice the rated power output or less per channel with all channels operating for any combination of frequencies from 20Hz to 20,000Hz

Wide Band Damping Factor

Greater than 70 at 4 ohms
Greater than 140 at 8 ohms

Input Impedance

20,000 ohms Balanced
10,000 ohms Unbalanced

Voltage Gain

29dB

Power Guard

Less than 2% THD with up to 14dB overdrive at 1,000Hz

Power Control Inputs ZA and ZB

5-15VDC, less than 1mA

Power Control Output ZA and ZB

12VDC, 50mA maximum total
Output is delayed 0.2 seconds from turn On

Power Requirements

Field AC Voltage conversion of the MC255 is not possible. The MC255 is factory configured for one of the following AC Voltages:

100 Volts, 50/60Hz at 12.0 Amps
110 Volts, 50/60Hz at 11.0 Amps
120 Volts, 50/60Hz at 10.0 Amps
127 Volts, 50/60Hz at 10.0 Amps
220 Volts, 50/60Hz at 6.0 Amps
230 Volts, 50/60Hz at 6.0 Amps
240 Volts, 50/60Hz at 6.0 Amps
Standby: less than 0.5 watt

Note: Refer to the rear panel of the MC255 for the correct voltage.

Overall Dimensions

Width is 17-1/2 inches (44.5cm)
Height is 9-7/16 inches (23.9cm) including feet
Depth is 21 inches (53.3cm) including the Front Panel and Cables

Weight

89.5 pounds (40.6 kg) net, 122.5 pounds (55.6 kg) in shipping carton

Shipping Carton Dimensions

Width is 29-1/2 inches (74.9cm)
Height is 17 inches (43.2cm)
Depth is 29 inches (73.7cm)

Packing Instructions

In the event it is necessary to repack the equipment for shipment, the equipment must be packed exactly as shown below. It is very important that the four plastic feet are attached to the bottom of the equipment. Four 1/4 - 20 x 2-1/4 inch screws and washers must be used to fasten the unit securely to the bottom pad and shipping skid. This will ensure the proper equipment location on the bottom pad. Failure to do this will result in shipping damage.

Use the original shipping carton and interior parts only if they are all in good serviceable condition. If a shipping carton or any of the interior part(s) are needed, please call or write Customer Service Department of McIntosh Laboratory. Refer to page 2. Please see the Part List for the correct part numbers.

Quantity	Part Number	Description
1	034052	Shipping carton top
1	034051	Shipping carton bottom
2	034054	Foam Pad (top and bottom)
2	034186	Foam Pad (front and rear)
2	034187	Foam Pad (sides)
1	034136	Inner carton top
1	034137	Inner carton bottom
1	034188	Foam Pad (inner carton)
1	034479	Shipping skid
4	101212	1/4 - 20x2-1/4 cap screw
4	104058	Flat washer

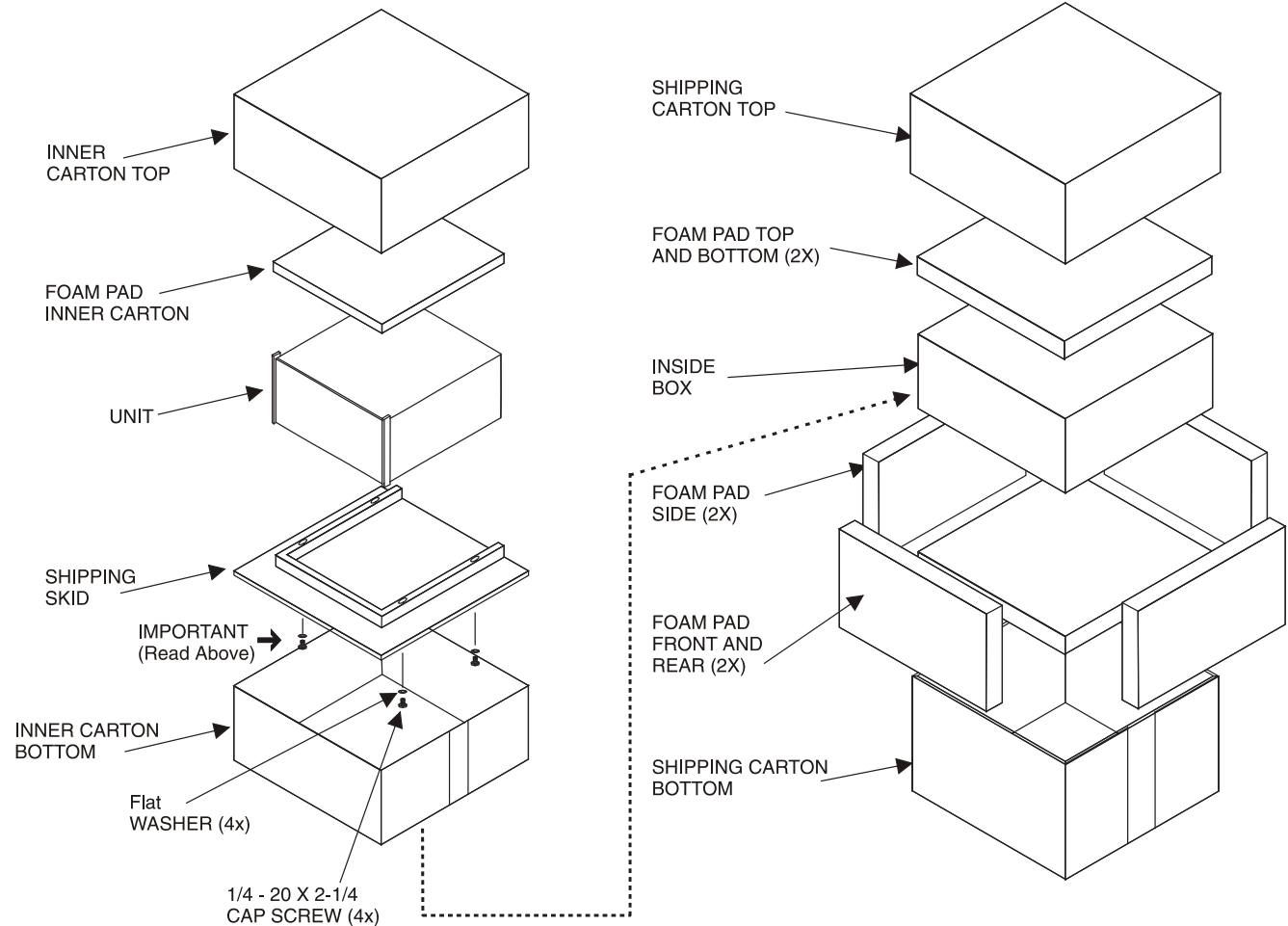



McIntosh Laboratory, Inc.
2 Chambers Street
Binghamton, NY 13903
www.mcintoshlabs.com

The continuous improvement of its products is the policy of McIntosh Laboratory Incorporated who reserve the right to improve design without notice.
Printed in the U.S.A.