



McIntosh Laboratory, Inc. 2 Chambers Street Binghamton, New York 13903-2699 Phone: 607-723-3512 [www.mcintoshlabs.com](http://www.mcintoshlabs.com)

MA8900  
Integrated Amplifier  
Owner's Manual





**Important Safety Information is supplied in a separate document “Important Additional Operation Information Guide”**

**Thank You**

Your decision to own this McIntosh MA8900 Integrated Amplifier ranks you at the very top among discriminating music listeners. You now have “The Best.” The McIntosh dedication to “Quality,” is assurance that you will receive many years of musical enjoyment from this unit.

Please take a short time to read the information in this manual. We want you to be as familiar as possible with all the features and functions of your new McIntosh.

**Please Take A Moment**

The serial number, purchase date and McIntosh Dealer name are important to you for possible insurance claim or future service. The spaces below have been provided for you to record that information:

Serial Number: \_\_\_\_\_

Purchase Date: \_\_\_\_\_

Dealer Name: \_\_\_\_\_

**Technical Assistance**

If at any time you have questions about your McIntosh product, contact your McIntosh Dealer who is familiar with your McIntosh equipment and any other brands that may be part of your system. If you or your Dealer wish additional help concerning a suspected problem, you can receive technical assistance for all McIntosh products at:

McIntosh Laboratory, Inc.  
2 Chambers Street  
Binghamton, New York 13903  
Phone: 607-723-3512  
Fax: 607-724-0549

**Customer Service**

If it is determined that your McIntosh product is in need of repair, you can return it to your Dealer. You can also return it to the McIntosh Laboratory Service Department. For assistance on factory repair return procedure, contact the McIntosh Service Department at:

McIntosh Laboratory, Inc.  
2 Chambers Street  
Binghamton, New York 13903  
Phone: 607-723-3515  
Fax: 607-723-1917

**Table of Contents**

Safety Instructions.....	2
(Separate Sheet).....	<b>Important Additional</b>
	<b>Operation Information Guide</b>
Thank You and Please Take a Moment.....	2
Technical Assistance and Customer Service.....	2
Table of Contents.....	2
General Information.....	3
Connector and Cable Information.....	3
Introduction.....	4
Performance Features.....	4
Dimensions.....	5
Installation.....	6
<b>Connections:</b>	
Rear Panel Connections.....	7
(Separate Sheet).....	<b>Mc1A</b>
Connecting Components.....	8
Connection Diagrams (Separate Sheet).....	<b>Mc2A/2B</b>
Passthru Connections.....	9
Connecting for Bi-Amplification.....	10
Connecting Loudspeakers.....	11-12
<b>Remote Control and Front Panel:</b>	
Remote Control Push-buttons.....	14
How to use the Remote Control.....	15

Copyright 2017 © by McIntosh Laboratory, Inc.

Front Panel Displays, Controls, Push-buttons and Jack.....	16
<b>Setup Mode:</b>	
How to Operate the Setup Mode.....	17
<b>Setup Functions:</b>	
Default Settings.....	17
Firmware Version.....	17
Source Input Renaming.....	17-19
Output Settings.....	19
Power Control Triggers 1 and 2.....	20
Data Ports.....	20
Passthru.....	21
Comm Port Baud Rate.....	21
Remote Control Codes.....	21
IR Sensor.....	22
Power Mode.....	22
Factory Reset.....	22
Microprocessor Reset.....	23
<b>Operation:</b>	
How to Operate the MA8900.....	24-31
<b>Trim Functions:</b>	
Balance.....	24
Equalizer Mode.....	25
Trim Level.....	25
Phono Adjustments.....	25
Mono/Stereo Mode.....	26
Meter Backlight.....	26
Display Brightness.....	26
Headphone HXD.....	27
Equalizer, Trim, Mute, Headphone Jack.....	27
Power Output Meters, Power Guard.....	27
How to Make a Recording.....	28
Using a Separate Power Amplifier.....	28
Using Output 2 and Passthru.....	28
Equalizer Controls.....	29
Optical and Coaxial Digital Inputs.....	29
USB Input Operation with a Computer.....	30
Resetting the MA8900 to default settings.....	30
Photo.....	32
Specifications.....	33-34
Packing Instructions.....	35

## General Information

- For additional connection information, refer to the owner's manual(s) for any component(s) connected to the MA8900.
- Apply AC Power to the MA8900 and other McIntosh Component(s) only after all the system components are connected together. Failure to do so may cause a malfunction of system operations as the Microprocessor's Circuitry inside the components is active when AC Power is applied.
- The MA8900 includes an Auto Off Power Save Feature and the default setting is enabled.** For additional information including how to disable it, refer to page 22.
- When Power Amplifier Protection Circuitry of the MA8900 has activated, the Front Panel Power Guard LEDs are illuminated continuously and the sound will be muted.
- When the Power Transformer has overheated due to improper ventilation and/or high ambient operating temperature, AC Power is removed from the MA8900. Normal operation will resume when the operating temperature is in a safe range again.
- For the best performance and safety, it is important to always match the impedance of the Loudspeaker to the Power Amplifier connections. Refer to pages 10 thru 12.  
*Note: The impedance of a Loudspeaker actually varies as the Loudspeaker reproduces different frequencies. As a result, the nominal impedance rating of the Loudspeaker (usually measured at a midrange frequency) might not always agree with the impedance of the Loudspeaker at low frequencies where the greatest amount of power is required. Contact the Loudspeaker Manufacturer for additional information about the actual impedance of the Loudspeaker before connecting it to the McIntosh MA8900.*

- The MA8900 Remote Control is capable of operating other components. For additional information go to [www.mcintoshlabs.com](http://www.mcintoshlabs.com).
- The IR Input, with a 1/8 inch mini phone jack, is configured for non-McIntosh IR sensors such as a Xantech Model DL85K Kit. Use a Connection Block such as a Xantech Model ZC21 when two or more IR sensors need to be connected to the MA8900. The signal from a connected External IR Sensor will have priority over the signal from the Front Panel IR Sensor.
- When discarding the unit, comply with local rules or regulations. Batteries should never be thrown away or incinerated but disposed of in accordance with the local regulations concerning battery disposal. 
- For additional information on the MA8900 and other McIntosh Products please visit the McIntosh Web Site at [www.mcintoshlabs.com](http://www.mcintoshlabs.com).

## Connector and Cable Information

### XLR Connectors

Below is the Pin configuration for the XLR Balanced Input Connectors on the MA8900. Refer to the diagram for connection:

- PIN 1: Shield/Ground
- PIN 2: + Output
- PIN 3: - Output

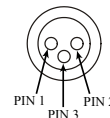

### Power Control and Trigger Connectors

The Power Control Trigger Output Jacks send and Passthru Input Jack receives Power On/Off Signals (+12 volt/0 volt) when connected to other McIntosh Components. An additional connection is for controlling the illumination of the Power Output Meters

#### Main, Trig 1&2 and Pass-Thru

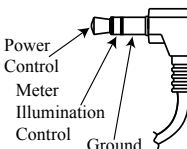

on McIntosh Power Amplifiers. A 3.5mm stereo mini phone plug is used for connection to the Power Control, Trigger and Passthru Outputs.

### Data Port Connectors

The Data Out Ports send Remote Control Signals to Source Components. A 3.5mm stereo mini phone plug is used for connection.

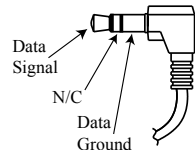

### IR IN Port Connectors

The IR IN Port also uses a 3.5mm stereo mini phone plug and allows the connection of other brand IR Receivers to the MA8900.

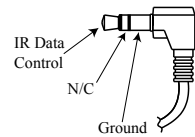

### RS232-C Data Port Cable

The RS232 Data Cable is a 3.5mm stereo mini phone plug to a sub miniature DB 9 connector:

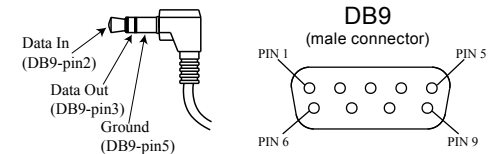

### Output Terminal Connector

When cables with spade lugs are used for Loudspeaker Connection, the spade lugs need an opening of at least 3/10 inch (7.6mm)

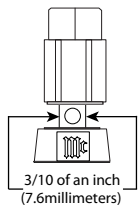

### McIntosh Plug-In Jumper Connector

The MA8900 utilizes two phono style Plug-In Jumpers to connect the Preamplifier Output to the Power Amplifier Input.

*Note: The Jumper Connector is available from the McIntosh Parts Department: **McIntosh Jumper Connector Part No. 117781***

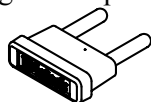



### Introduction

Now you can take advantage of traditional McIntosh standards of excellence in the MA8900 Integrated Amplifier. The Power Amplifier section of the MA8900, with a power output of 200 watts per channel, will drive a pair of quality Loudspeakers to a high level of performance.

The flexible Preamplifier section provides connections for various input sources and may also be used to drive an external Power Amplifier(s).

The MA8900 reproduction is sonically transparent and absolutely accurate. The McIntosh Sound is “The Sound of the Music Itself.”

### Performance Features

#### • Power Output with Patented Autoformer

The MA8900 consists of a 200 watts per channel Power Amplifier with less than 0.005% distortion. The McIntosh designed and manufactured Autoformer allows connection of 2, 4 or 8 ohm Loudspeakers. The Power Amplifier uses ThermalTrak<sup>1</sup> Output Transistors for lower distortion and cool operation.

#### • Power Guard

The patented McIntosh Power Guard circuit prevents amplifier clipping and protects your valuable Loudspeakers.

#### • Sentry Monitor and Thermal Protection

McIntosh Sentry Monitor power output stage protection circuits ensure the MA8900 will have a long and trouble free operating life. Built-in Thermal Protection Circuits guard against overheating.

#### • Electronic Switching and Balanced Connections

The Preamplifier uses Logic Circuits Controlled

Electromagnetic Switches on all inputs and operating functions for reliable, noiseless, distortion free switching. There is a Balanced Input for connection of a source component.

#### • Digital Audio Inputs

The Digital Inputs decode PCM and DSD Signals from external sources. Coaxial and Optical Inputs process Digital Signals up to 192kHz with 24-Bit resolution. The Digital MCT Input Circuitry directly decodes SACD/CD signals from an external Transport component. The USB Input for streaming audio processes Digital Signals up to 384kHz with 32-Bit resolution, decodes up to DSD256 Digital Signals and DXD 24-Bit with a sampling rate up to 384kHz.

#### • Moving Coil and Moving Magnet Phono Inputs

The MA8900 has two precision Phono Preamplifier Circuits for Moving Coil and Moving Magnet Phono Cartridges. Both circuits use the latest designs to provide the lowest possible noise, distortion and flat frequency response. The MC Phono Cartridge Input has selectable loading.

#### • Five Band Equalizer

The Equalizer Controls provide  $\pm 12$ dB at center frequencies of 30, 125, 500, 2,000 and 10,000Hz. There is also an Equalizer Bypass Mode to remove the Equalizer from the Signal Path of any selected input.

#### • Multifunction Display and Power Meters

The Front Panel Display indicates source selection, volume levels and setup functions. The Illuminated Power Output Meters are peak responding, and indicate the power output of the amplifier.

#### • Power Control Output and Trigger Assignment

A Power Control connection for convenient Turn-On of McIntosh Power Amplifiers, Source Components and Accessories is included. The Power Control Trigger Outputs may be assigned to activate when a given Input/Output is selected.

#### • PassThru Mode

The Automatic PassThru Mode allows the MA8900 to become part of a Multichannel Sound System for DVD-Audio, SACD and Home Theater Movies.

#### • Remote Control

The Data Ports together with the supplied Remote Control provide control of McIntosh Source Components connected to the MA8900.

#### • Special Power Supply

The large Power Transformer, multiple filter capacitors with 120 Joules of Energy Storage and regulated Power Supply, ensures stable noise free operation even though the power line varies.

#### • McIntosh Custom Binding Posts

McIntosh Patented gold plated output terminals deliver high current output. They accept large diameter wire and spade lugs. Banana plugs may also be used only in the United States and Canada.

#### • Glass Front Panel and Super Mirror Chassis Finish

The famous McIntosh Illuminated Glass Front Panel uses long life Light Emitting Diodes (LEDs) and the Stainless Steel Chassis with Super Mirror Finish ensures the pristine beauty of the MA8900 will be retained for many years.

<sup>1</sup> ThermalTrak™ and ON Semiconductor are trademarks of Semiconductor Components Industries, LLC

**Dimensions**

The following dimensions can assist in determining the best location for your MA8900. There is additional information on the next page pertaining to installing the MA8900 into cabinets.

**Front View of the MA8900**

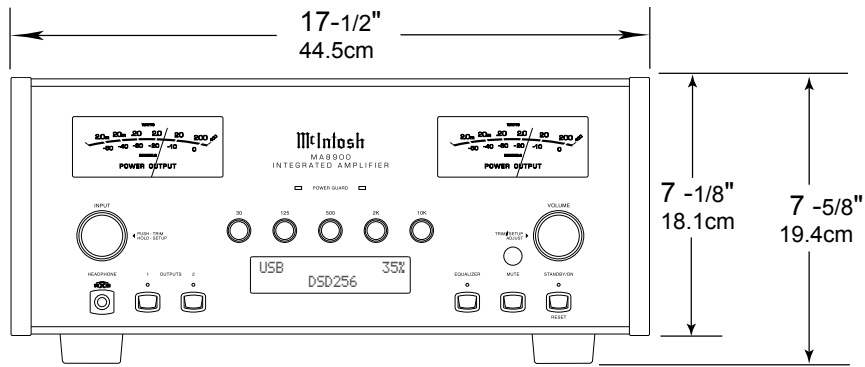

**Rear View of the MA8900**

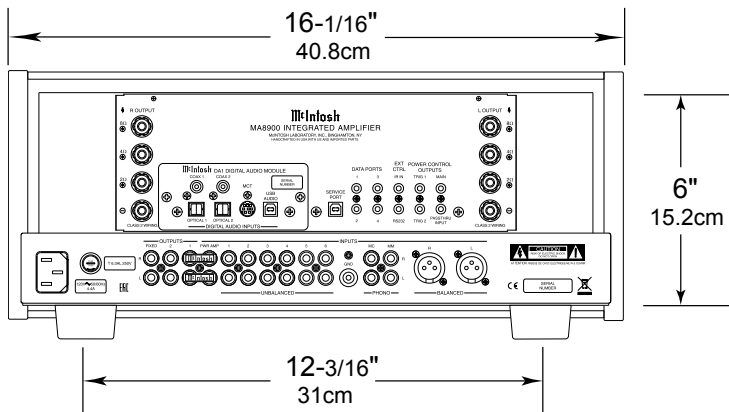

**Side View of the MA8900**

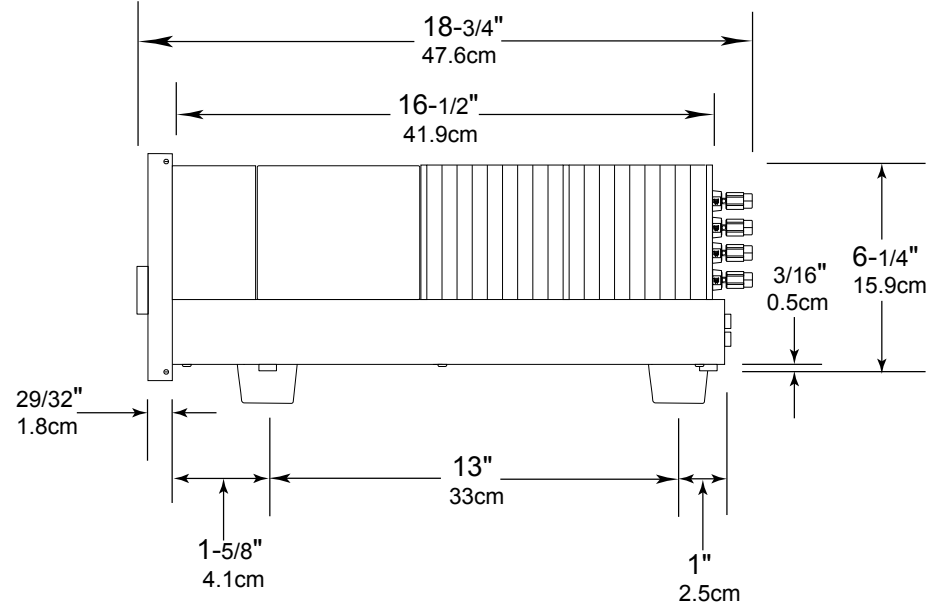

## Installation

The MA8900 can be placed upright on a table or shelf, standing on its four feet. It also can be custom installed in a piece of furniture or cabinet of your choice. The four feet may be removed from the bottom of the MA8900 when it is custom installed as outlined below. The four feet together with the mounting screws should be retained for possible future use if the MA8900 is removed from the custom installation and used free standing. The required panel cutout, ventilation cutout and unit dimensions are shown.

Always provide adequate ventilation for your MA8900. Cool operation ensures the longest possible operating life for any electronic instrument. Do not install the MA8900 directly above a heat generating component such as a high powered amplifier. If all the components are installed in a single cabinet, a quiet running ventilation fan can be a definite asset in maintaining all the system components at the coolest possible operating temperature.

A custom cabinet installation should provide the following minimum spacing dimensions for cool operation.

Allow at least 6 inches (15.24cm) above the top, 2 inches (5.08cm) below the bottom and 2 inches (5.1cm) on each side of the Integrated Amplifier, so that air-flow is not obstructed. Allow 20 inches (50.8cm) depth behind the front panel. Allow 1-7/6 inch (3.66cm) in front of the mounting panel for knob clearance. Be sure to cut out a ventilation hole in the mounting shelf according to the dimensions in the drawing.

**MA8900 Front Panel  
Custom Cabinet Cutout**

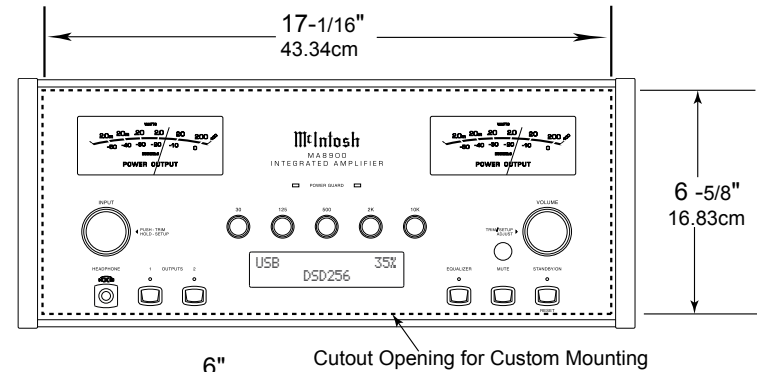

**MA8900 Side View  
in Custom Cabinet**

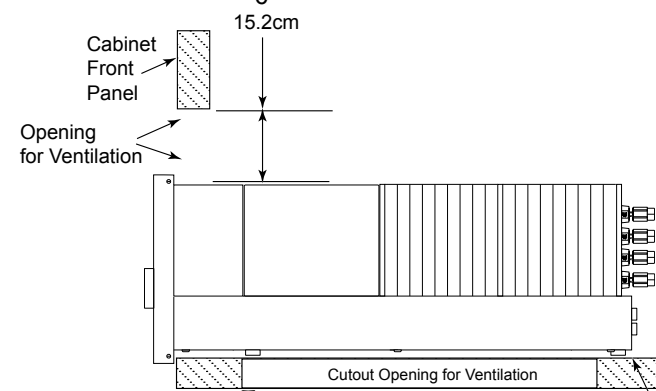

**MA8900 Bottom View  
in Custom Cabinet**

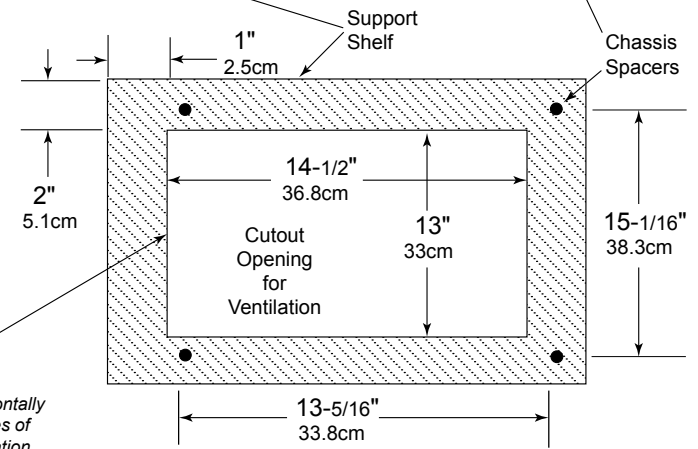

*Note: Center the cutout horizontally on the unit. For purposes of clarity, the above illustration is not drawn to scale.*



## Rear Panel Connections

The identification of Rear Panel Connections for the MA8900 Integrated Amplifier is located on a separate folded sheet contained in the Owner's Manual Packet. Refer to separate sheet "McIA" for the Rear Panel Connections.

MA8900 Integrated Amplifier

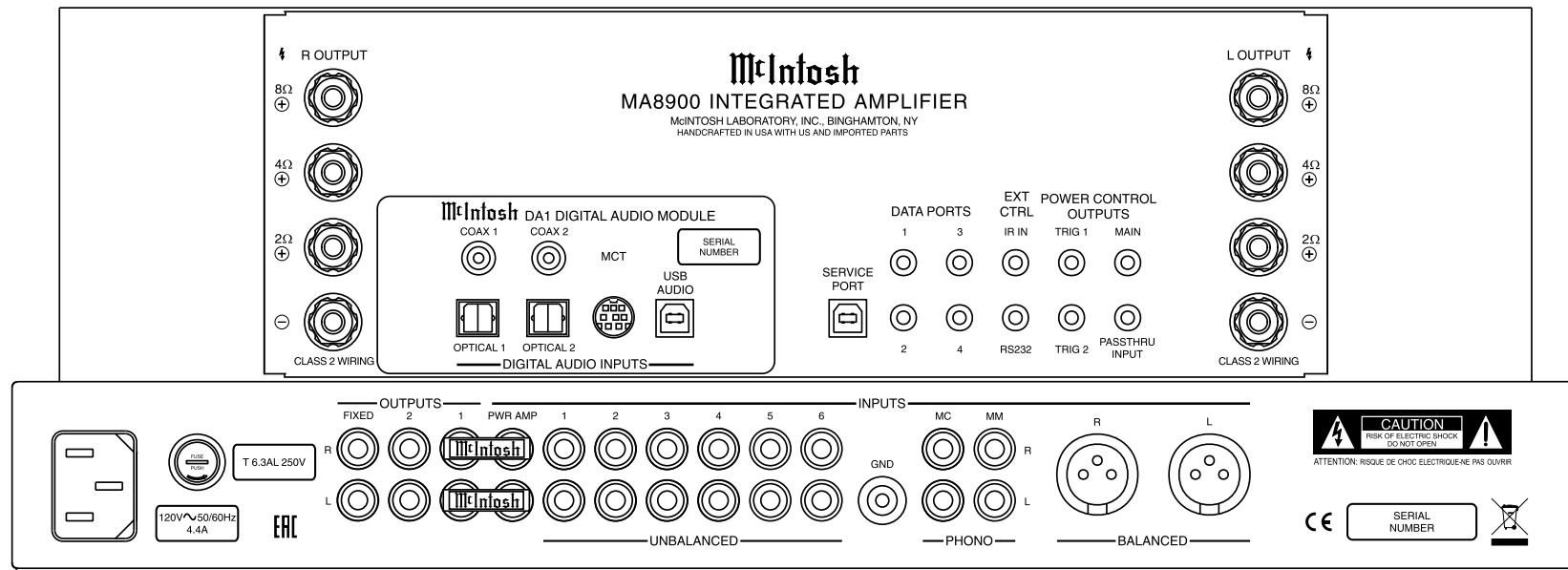

## Connecting Components

The MA8900 has the ability to automatically switch power On/Off to McIntosh Source Components via the Power Control (Trigger) connections. The Data Port Connections allow for the remote operation of basic functions using the MA8900 Remote Control. With an external sensor connected to the MA8900, remote control operation of the system is possible from another room and/or when the MA8900 is located in a cabinet with the doors closed.

The connection instructions below, together with the MA8900 Input and Output Connection Diagrams located on the separate folded sheet “**Mc2A/2B**”, are an example of a typical audio system. Your system may vary from this, however the actual components would be connected in a similar manner. For additional information refer to “Connector and Cable Information” on page 3.

### **Power Control Connections:**

1. Connect a Control Cable from the MA8900 POWER CONTROL MAIN Jack to the Power Control In on the Turntable.
2. Connect a Control Cable from the McIntosh Turntable Power Control Out Jack to the Digital Audio Player Trigger In Jack.
3. Connect a Control Cable from the Digital Audio Player Trigger Out Jack to the SACD/CD Transport Power Control In Jack.
4. Connect a Control Cable from the SACD/CD Transport Power Control Out Jack to the AM/FM Tuner Power Control In Jack.
5. Connect a Control Cable from the AM/FM Tuner Power Control Out Jack to the Media Server PWR CTRL (Power Control) In Jack.

6. Optionally connect a Control Cable from the MA8900 POWER CONTROL TRIG (Trigger) 2 Jack to the Power Amplifier (Secondary Room) Power Control In Jack.
7. Connect any additional McIntosh Components in a similar manner, as outlined in steps 1 thru 4.

### **Data Control Connections:**

8. Connect a Control Cable from the MA8900 DATA PORT Jack 3 to the SACD/CD Player Data In Jack.
9. Connect a Control Cable from the MA8900 DATA PORT Jack 2 to the AM/FM Tuner Data In Jack.
10. Connect a Control Cable from the MA8900 Jack 1 to the Media Server Data In Jack.
11. Connect any additional McIntosh Components in a similar manner, as outlined in steps 8 thru 10.

### **Sensor Connection:**

12. Optionally, connect the cable with stereo mini plug coming from the compatible External Sensor to the EXT CTRL (External Control) IR IN Jack on the MA8900. Refer to page 3 “General Information, note 8” for additional information.

### **Audio Connections:**

13. Connect Balanced Cables from the MA8900 BALANCED INPUT L & R Connectors to the Media Server Audio Output Balanced Connectors.
14. Connect Audio Cables from the MA8900 Number 1 UNBALANCED Jacks to the AM/FM Tuner UNBAL Output Jacks.
15. Connect the Audio Cables coming from the Turntable to the MA8900 MC (for a Moving Coil Cartridge) or MM (for a Moving Magnet Cartridge) INPUT Jacks.
16. Optionally, connect Audio Cables from the MA8900 OUTPUT 2 Jacks to the Power Amplifier

(Secondary) Input Jacks.

17. Connect any additional Components in a similar manner, as outlined in steps 13 thru 16.

### **Optional Digital Audio Connections:**

18. Connect an Optical Cable from the MA8900 OPTICAL 1 Digital Audio Input Connector to the Digital Audio Out Optical Connector on the Digital Audio Player.
19. Using the “DIN Cable-Twisted Pair” cable (supplied with a MCT Transport), connect the cable from the MA8900 MCT DIGITAL AUDIO INPUT Connector to the SACD/CD Transport DIN Output Connector.

### **Optional USB Connection:**

20. Connect a USB cable with (Type A to Type B) connectors from the MA8900 USB D/A Digital Audio Input to an available USB connector.

### **Ground Connections:**

21. Connect the Ground Cable coming from the Turntable to the MA8900 GND Binding Post.

*Notes: 1. If the MA8900 is part of a Home Theater System, proceed to “PassThru” connection on page 9.*  
*2. When the MA8900 will be used together with a separate Power Amplifier for Bi-Amplification of a Loudspeaker System, proceed page 10.*



### Passthru Connections

The MA8900 can be part of a Multichannel Sound System for BLU-RAY-Audio, DVD-Audio and Home Theater Movies. The Right and Left Front Channels from an Audio/Video Control Center can “Passthru” the MA8900. In the following example the UNBALANCED 6 Input will become the “Passthru” input:

1. Connect Audio Cables from the A/V Processor FL (Front Left) and FR (Front Right) Channel Outputs to the MA8900 UNBALANCED Number 6 INPUTS Left and Right Jacks.
  2. Connect a Control Cable from the A/V Processor TRIGGER 2 Output to the MA8900 POWER CONTROL PASSTHRU INPUT Jack.
- Note: Refer to Setup “Passthru” on page 21 to assign the Number 6 INPUT as the “Passthru” Input.*
3. Proceed to “Connecting Loudspeaker” on Page 11.

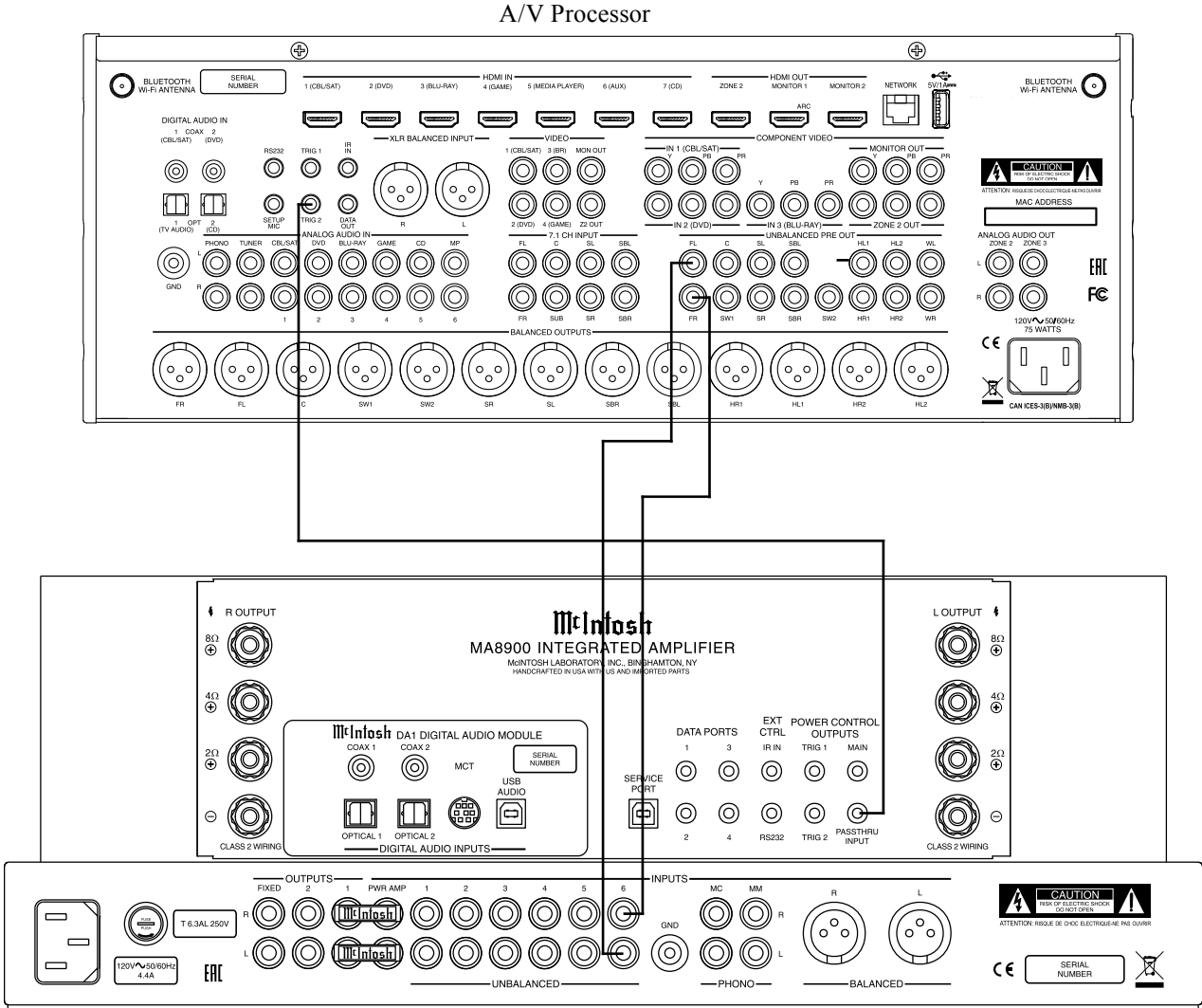



### Connecting for Bi-Amplification

The MA8900 Power Amplifier, together with an additional separate Power Amplifier, may be used to Bi-Amplify a Loudspeaker System. In the illustration on this page, the Power Amplifier of the MA8900 is connected to the Midrange/High Frequency Section of the Loudspeaker. The additional separate Power Amplifier is connected to the Low Frequency Section of the Loudspeaker System.

**Warning:** *The Loudspeaker System used for Bi-Amplification must have the jumpers removed from between the MID/HIGH and LOW Frequency Sections of the Loudspeaker System. Failure to remove them could result in damage to the MA8900 and/or the separate Power Amplifier.*

#### MA8900 Connections:

1. Remove the “McIntosh Jumpers” from between the OUTPUT 1 Jacks and the PWR AMP In Jacks located on the Rear Panel of the MA8900.

*Note: Place the “McIntosh Jumper” in a safe place for possible future use.*

2. Using a pair of shielded RCA Type Audio “Y” Adapters connect the OUTPUT 1 Jacks to the PWR AMP In Jacks, for both Left and Right Channels.
3. Connect the remaining unconnected part of the “Y” Adapters to the separate Power Amplifier.
4. Referring to the Loudspeaker Connection Instructions on page 11, and in the Owner’s Manual supplied with the Power Amplifier and Loudspeaker, connect the MA8900 Output Terminals to the Loudspeaker MID/HIGH Input Terminals.

*Note: The Loudspeaker Connection illustrations on this page are for the Left Channel. Connect the Right Channel Loudspeaker in the same manner.*

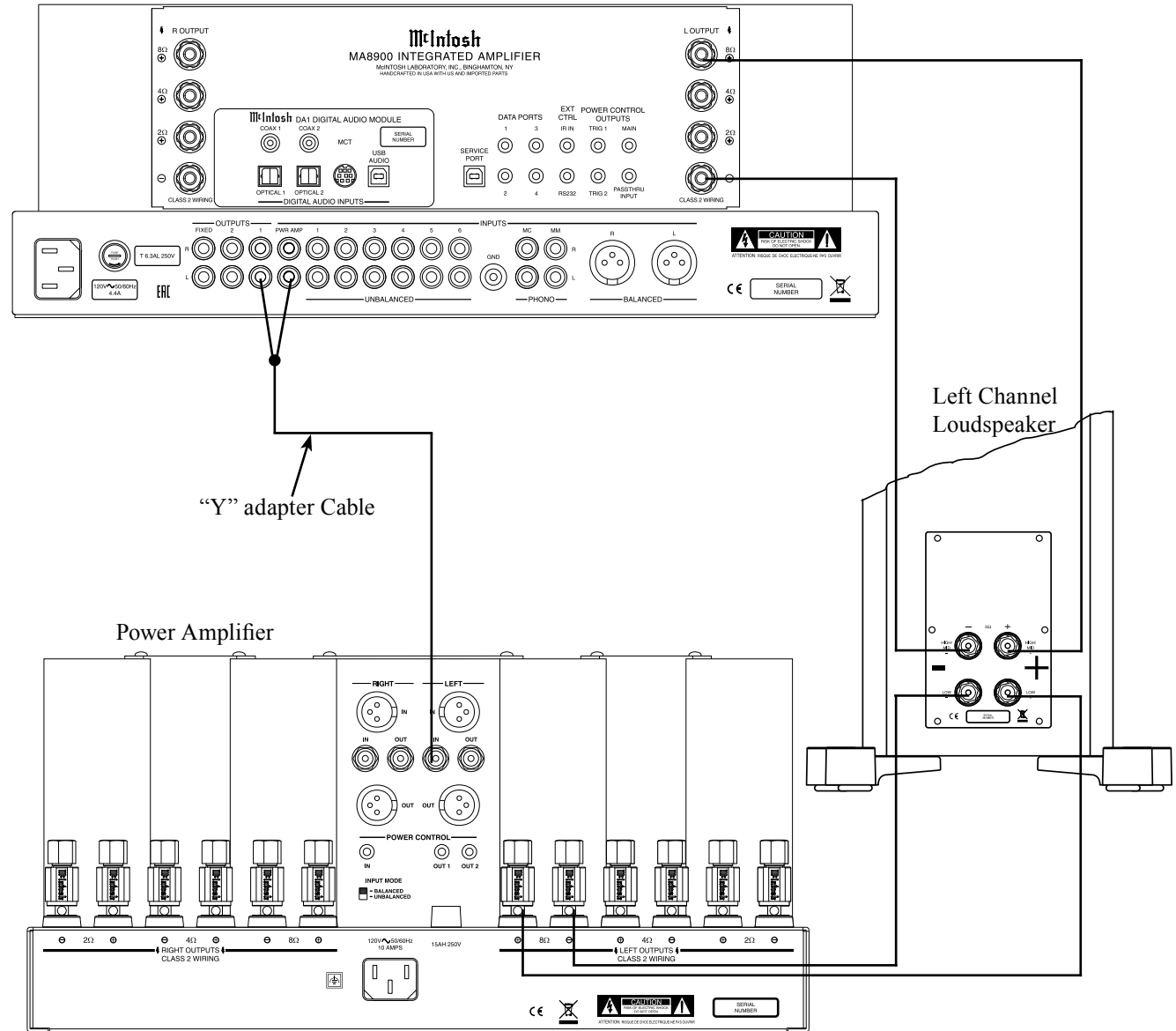

## Output Terminals

When connecting the Loudspeaker Hookup Cables to the MA8900 Amplifier Output Terminals please follow the steps below:

1. Rotate the top of the Output Terminal Post counterclockwise until an opening appears. Refer to figures A and B.
2. Insert the Loudspeaker hookup cable into the Output Terminal Post opening or the cable spade lug around the center post of the Output Terminal. Refer to figure C.
3. Rotate the top of the Output Terminal Post clockwise until it is finger tight. Refer to figure D.
4. Place the supplied McIntosh Wrench over the top of the Output Terminal and rotate it one quarter of a turn (90°) to secure the Loudspeaker Cable Connection. **Do not over tighten.** Refer to figure E.

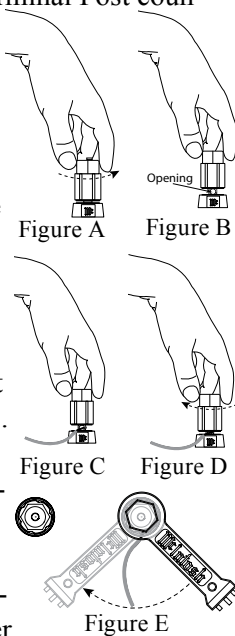

## How to Connect Loudspeakers

**Caution:** Do not connect the AC Power Cord to the MA8900 Rear Panel until after the Loudspeaker Connections are made. Failure to observe this could result in Electric Shock.

The connection instructions below, together with the MA8900 Connection Diagram located on the separate folded sheet “Mc2B”, is an example of a typical audio system. Your system may vary from this, however the actual components would be connected in a similar manner. For additional information refer to “Connector and Cable Information” on page 3.

The McIntosh MA8900 Power Amplifier Circuitry is designed for Loudspeakers with an impedance of 2 ohms, 4 ohms or 8 ohms. Connect a single Loudspeaker only to the Right and Left Output Terminals.

When connecting Loudspeakers to the MA8900 it is very important to use cables of adequate size, so there is little to no power loss in the cables. The size is specified in Gauge Numbers or AWG (American Wire Gauge). The smaller the Gauge number, the larger the wire size:

Loudspeaker Cable Distance vs Wire Gauge Guide			
Loudspeaker Impedance	25 feet (7.62 meters) or less	50 feet (15.24 meters) or less	100 feet (30.48 meters) or less
2 Ohms	12AWG	10AWG	8AWG
4 Ohms	14AWG	12AWG	10AWG
8 Ohms	16AWG	14AWG	12AWG

1. Prepare the Loudspeaker Hookup Cable for attachment to the MA8900 Power Amplifier:

Bare wire cable ends:

Carefully remove sufficient insulation from the cable ends, refer to figures F, G & H. If the cable is stranded, carefully twist the strands together as tightly as possible.

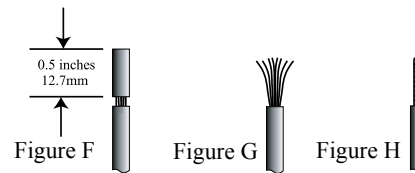

- Notes:
1. If desired, the twisted ends can be tinned with solder to keep the strands together.
  2. The prepared bare wire cable ends may be inserted into spade lug connectors.
  3. Banana plugs are for use in the United States and Canada only.

**Banana Plugs are for use in the United States and Canada only:**

2. Attach the previously prepared bare wire cable ends into the banana plugs and secure the connections. Refer to figure I.
3. Rotate the Output Terminal Post clockwise until it is finger tight. Refer to figure J. Then using the McIntosh Wrench, rotate the top of the Output Terminal one quarter of a turn (90°). **Do not over tighten.** Refer to figure E.
4. Referring to figure K, connect the Loudspeaker hookup cables with banana plugs into the hole at the top of the terminal to the MA8900 Negative Output Terminal and Positive Output Terminal identified as 2Ω (ohms), 4Ω (ohms) or 8Ω (ohms) connection to match the impedance of the Loudspeaker, being careful to observe the correct polarities.

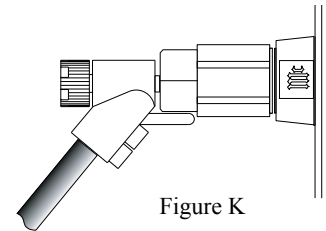
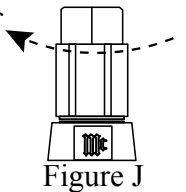
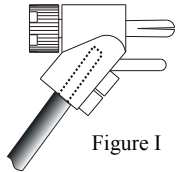

*Note:* The illustration located on the separate folded sheet “Mc2B” is for connection to an 8Ω (ohms) Loudspeaker.

If the Loudspeaker’s impedance is in-between the available connections, use the nearest lower impedance connection. Refer to “General Information” Note 6 on page 3 for additional information.

**WARNING:** Loudspeaker terminals are hazardous live and present a risk of electric shock. For additional instruction on making Loudspeaker Connections contact your McIntosh Dealer or McIntosh Technical Support.

5. Connect the MA8900 power cord to an active AC outlet.

### Spade Lug or Wire Connections:

6. Connect the Loudspeaker hookup cables to the MA8900 Negative Output Terminal and Positive Output Terminal indentified as  $2\Omega$  (ohms),  $4\Omega$  (ohms) or  $8\Omega$  (ohms) connection to match the impedance of the Loudspeaker, being careful to observe the correct polarities. Insert the spade lug connector or prepared section of the cable end into the terminal side access hole, and tighten the terminal cap until the cable is firmly clamped into the terminals so the lugs or wire cannot slip out. Refer to figures L and M.

*Note: The illustration located on the separate folded sheet "Mc2B" is for connection to an  $8\Omega$  (ohms) Loudspeaker.*

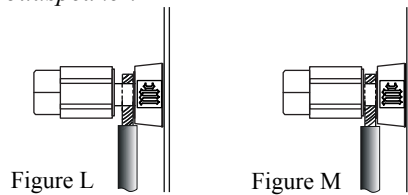

If the Loudspeaker's impedance is in-between the available connections, use the nearest lower impedance connection. Refer to "General Information" Note 6 on page 3 for additional information.

**WARNING: Loudspeaker terminals are hazardous live and present a risk of electric shock. For additional instruction on making Loudspeaker Connections contact your McIntosh Dealer or McIntosh Technical Support.**

7. Connect the MA8900 power cord to an active AC outlet.



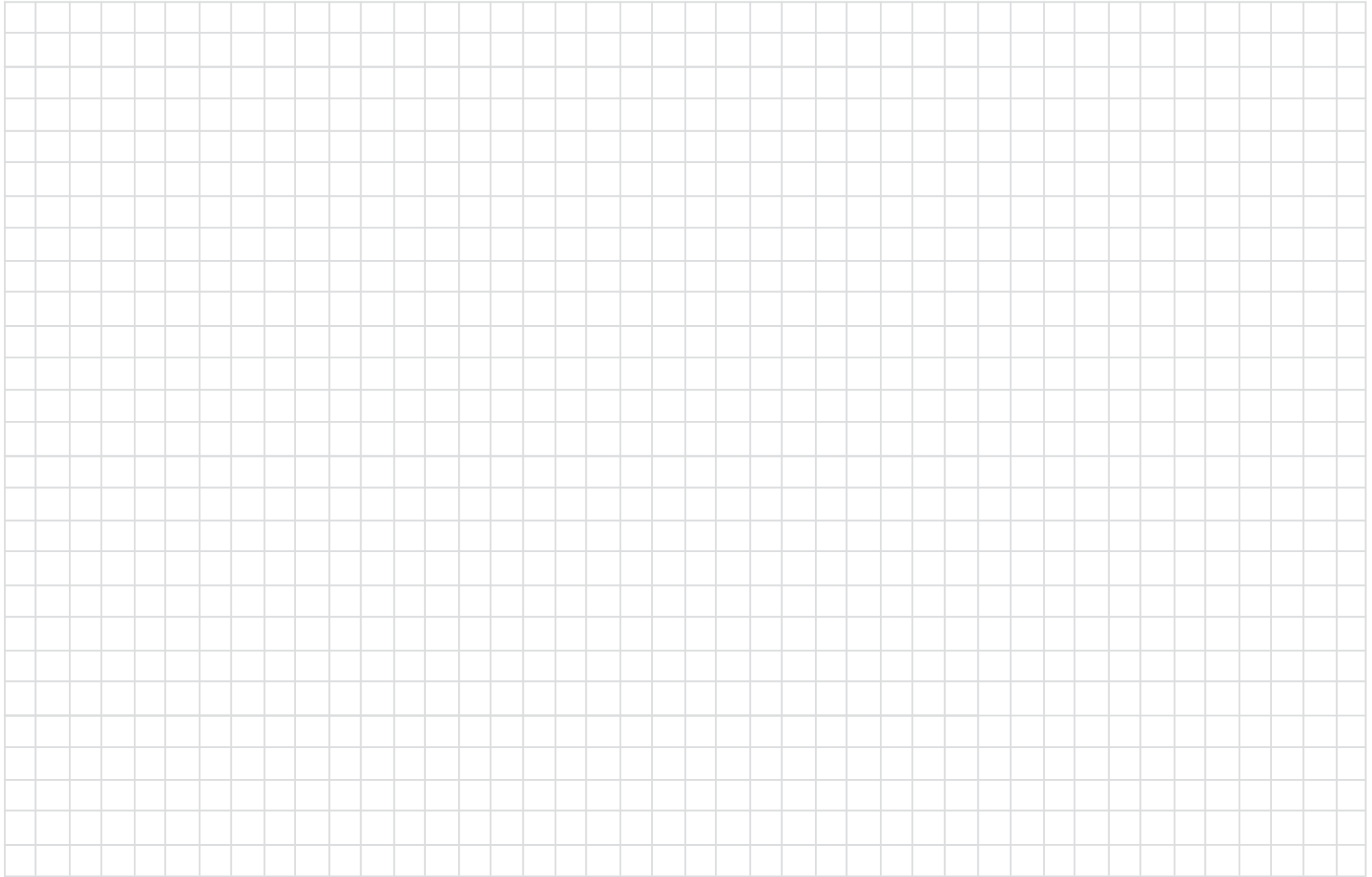



LEDs illuminate during the time a remote command is sent and when programming the remote control

Select the DEVICE to issue a remote control command to

SETUP Push-button is used as a "Shift Key" to select a function with blue color nomenclature

Selects AM Tuner Operating Functions, select Output 1 when used with the SETUP/shift Push-button and Track Selection on certain McIntosh CD Players

Press the Trim Push-button and then the LEVEL UP Push-button to select and adjust various functions. MENU is used with McIntosh Models displaying choices on a video screen

Activates the TRIM Mode. GUIDE is used with McIntosh Models displaying instructions on a video screen

Press the Trim Push-button and then the LEVEL DOWN Push-button to select and adjust various functions. INFO is used with McIntosh Models displaying information on a video screen

Scrolls through the available INPUTS

Mutes the audio

Selects transport functions of STOP, PLAY/PAUSE, RECORD, BACK for the previous-selection, FAST-REVERSE, FAST-FORWARD and NEXT for the next selection

Selects Previous Tuner Station PRESET

Tuner scans Down the dial to SEEK the next Station

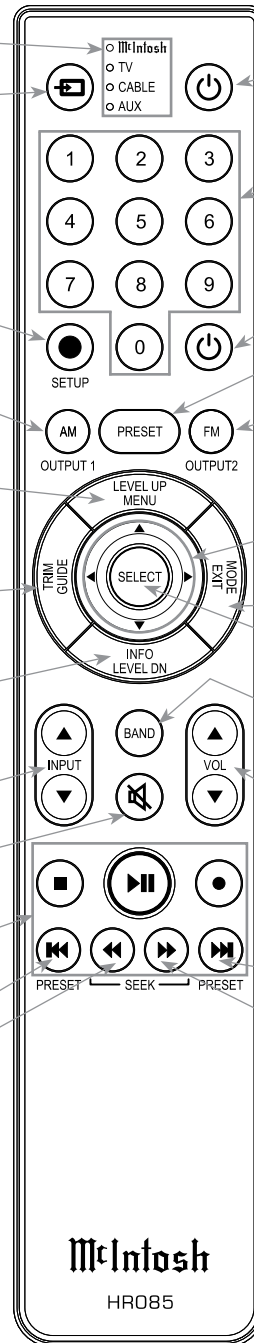

Press to Power the Integrated Amplifier ON

Use to select tuner presets, direct access an AM/FM Station Frequency, disc tracks or any numbered operation

Press to Power the Integrated Amplifier OFF

Direct access to stored Tuner PRESETS when used with the numeric Push-buttons (0 thru 9)

Selects FM Tuner Operating Functions, select Output 2 when used with the SETUP/shift Push-button and Track Selection on certain McIntosh CD Players

Use ▲ and ▼ to tune Up or Down the AM/FM Dial, use ► and ◀ for the next or previous HD Radio Program (were applicable)

EXIT the TRIM Menu and is used with McIntosh Models displaying information or choices on a video screen

Used to SELECT/Enter the indicated choice

Press to change Broadcast BANDs on a connected Tuner. Select certain functions on a variety of McIntosh Models

Adjusts the VOLume level up or down

Selects Next Tuner Station PRESET

Tuner scans Up the dial to SEEK the next Station

*Note: Push-buttons whose function is not identified above are for use with other McIntosh Products.*



## How to use the Remote Control

The supplied MA8900 Remote Control (HR085) is capable of directly controlling the functions of contemporary McIntosh Source Components connected to the MA8900 via the Data Ports.

- Notes:*
- 1. If at any time the MA8900 seems unresponsive to the HR085 Remote Control Commands, press the  DEVICE Push-button to select McIntosh first.*
  - 2. For additional information on using the HR085 Remote Control with the McIntosh Model, please refer to the "How to Operate" starting on page 24.*
  - 3. For additional information on assigning the Data Ports, refer to "Data Ports" on page 20.*

### Trim

Press the TRIM Push-button until the desired Trim function (Balance, Trim Level, etc.) appears on the MA8900 Front Panel Display, then press the LEVEL Up or Down Push-button to adjust the Trim setting.

*Note: Press the TRIM Push-button to recall the last Trim function selected. For additional information on using the Trim Functions refer to "How to Operate" page 24.*

### Output Selection

Press the BLUE (Setup) Push-button followed by the AM (Output 1) or FM (Output 2) Push-button, to control the Rear Panel Audio OUTPUTS 1, 2 (ON or OFF) and Power Control TRIG 1 / TRIG 2.

*Note: For additional information on assigning the Outputs (1 and 2) and Power Control Triggers (1 and 2) refer to pages 19 and 20.*





# Front Panel Displays, Controls, Push-buttons and Jack

INPUT Control used to select a source for listening and recording. The control is also used to enter the TRIM or SETUP Modes and select the various functions

LED indicates when the Left Channel Amplifier POWER GUARD circuit activates

LED indicates when the Right Channel Amplifier POWER GUARD circuit activates

VOLUME Control allows adjustment of the listening level for both channels. Also used to change the various TRIM and SETUP Functions

Meter indicates the Left Channel Output of the amplifier

EQUALIZER Controls increase or decrease the volume levels at the Center Frequencies of 30Hz, 125Hz, 500Hz, 2,000Hz and 10,000Hz

Meter indicates the Right Channel Output of the amplifier

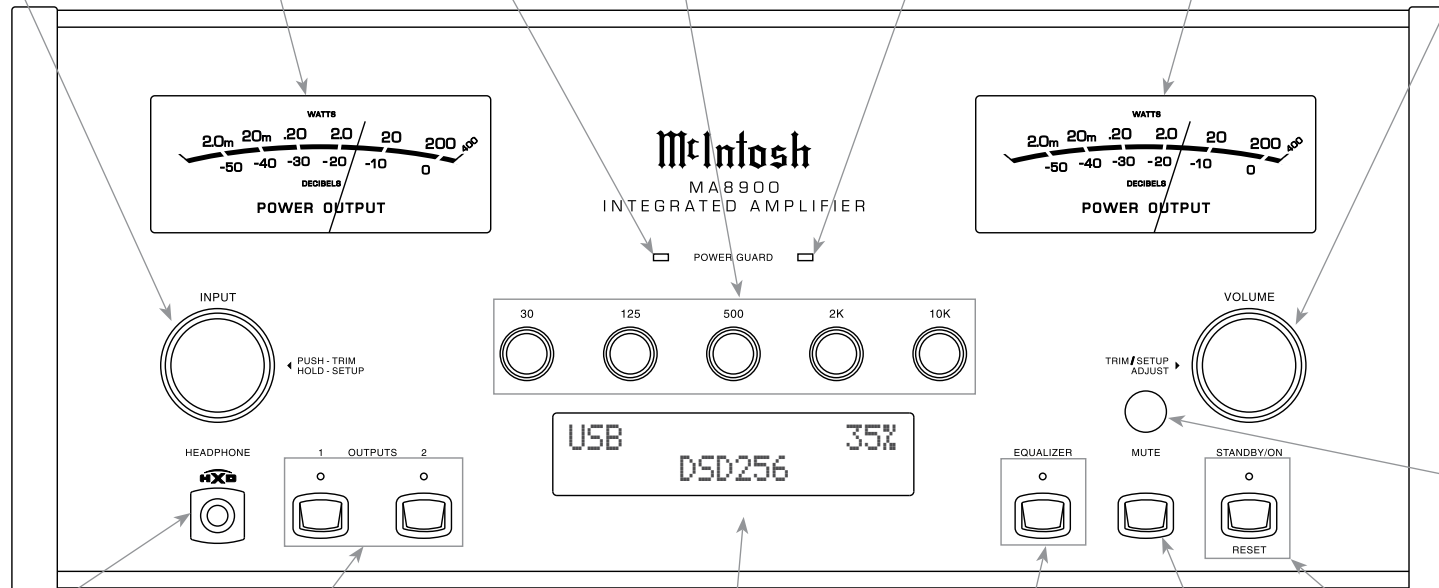

Connection for low impedance dynamic headphones, for private listening

OUTPUT 1 and 2 Push-buttons with indicators, switch Pre-amplifier Output (Loudspeakers) 1 and 2 On or Off

INFORMATION DISPLAY indicates the Sources, Volume, other Audio Settings, Operational Functions and Setup Mode Settings

EQUALIZER Push-button with indicator, when deactivated the audio signal bypasses the Equalizer Controls

MUTE Push-button mutes the audio from the Loudspeakers and Headphones

STANDBY/ON Push-button with indicator switches the MA8900 ON or OFF (Standby) and resets the microprocessors

IR Sensor receives commands from a Remote Control

## How to Operate the Setup Mode

Your McIntosh MA8900 has been factory configured to allow immediate enjoyment of superb audio without the need for further adjustments. If you wish to make changes to the factory default settings, a Setup Feature is provided to customize the operating settings using the Front Panel Information Display. Refer to the MA8900 Front Panel Illustration on the previous page while performing the following steps.

*Note: If the MA8900 is currently On, proceed to step 2.*

1. Press the STANDBY/ON Push-button on the Front Panel or press the  (Power ON) Push-button on the Remote Control to switch On the MA8900. The MA8900 will go through a brief startup initialization with the Front Panel Information Display first indicating “MA8900”, followed by the last used source and volume setting. This is followed by the volume setting indication starting at zero and then increasing to the last used volume setting. Refer to figure 1.



Figure 1

2. Press and hold in the INPUT Control until the Front Panel Information Display indicates “MA8900 V1.00, (or higher Main Firmware version) - S/N: AFJ\_\_\_\_\_” (Serial Number). Refer to figure 2.



Figure 2

3. Rotate the INPUT Control to select the Setup Mode Menu item, “SETUP: Inputs, (Hold INPUT)”. Refer to figure 3.

Figure 3

Continue to rotate the INPUT CONTROL to view the other SETUP Mode Options.

4. To exit from the SETUP Mode, press and hold in the INPUT Control and the Front Panel Display will indicate its normal display. Refer to figure 1.

### Default Settings

The Default Settings Chart below indicates the Function Name, Default Setting and the Page Number for additional information.

Default Settings		
Function Name	Setting	Page No.
MA8900	V_ _ _	17
DA1	V_ _ _	17
INPUTS	On / Rename	17-18
OUTPUTS (1 & 2)	Switched	19
TRIGGER 1	Output 1	20
TRIGGER 2	Output 2	20
DATA PORTS (1 thru 4)	All Data	20
PASSTHRU	OFF	21
USB Automute	ON	21
RS232 (Rate)	115200 Baud	21
Remote Control Codes	Normal	21
IR Sensor	Enabled	22
Power Mode	Enabled	22

### Firmware Version

The MA8900 functionality is controlled by internal software that is known as Firmware. There are two Firmware Identification Numbers for the MA8900. The first Firmware Number is for the Main Circuitry of the MA8900 and can be identified at any time by

utilizing the Setup Mode.

1. Press and hold in the INPUT Control to enter Setup Mode.
2. Referring to the Front Panel Information Display—the number after the character “V” is the Firmware number. Refer to figure 2.

To view the second Firmware Number, which is for the Digital Audio Circuitry of the MA8900, perform the following steps:

3. Press and hold in the INPUT Control to enter Setup Mode.
4. Rotate the INPUT Control until the Front Panel Information Display indicates “DA1 Firmware, V1.00” (or higher Digital Audio Firmware version). Refer to figure 4.

Figure 4

5. To exit the Setup Mode, press the INPUT Control.

### Input Settings

The MA8900 provides the ability to switch unused INPUTS Off (or back On if they have been previously switched Off). The default INPUT Names can be changed to match the name of the component connected to it or any other custom name desired (within 10 Characters).

#### INPUT SWITCHED ON/OFF:

In the following example, the UNBAL 4 Input will be switched Off.

*Note: When an INPUT is switched Off, its name will no longer appear on the Front Panel Information Display when using the INPUT Control (Front Panel or Remote Control).*

1. Press and hold in the INPUT Control to enter the SETUP MODE. Refer to figure 2.

## Input Settings, con't

2. Rotate the INPUT Control until "SETUP: Inputs, (Hold INPUT)" appears on the Information Display. Refer to figure 3 on page 17.
3. Press and hold in the INPUT Control until "SETUP: UNBAL 4, On / Name (Hold INPUT)" appears on the Display. If necessary rotate the INPUT Control to select the UNBAL 4 Input. Refer to figure 5.



Figure 5

4. To switch the UNBAL 4 Input Off, rotate the VOLUME Control until the display indicates "SETUP: UNBAL 4, Off". Refer to figure 6.



Figure 6

5. Exit the SETUP Mode by several presses of the INPUT Control.

In the following example, the UNBAL 4 Input will be switched On.

*Notes: 1. When an INPUT is switched ON, its name will appear on the Front Panel Information Display when using the INPUT Control (Front Panel or Remote Control).*

6. Press and hold in the INPUT Control to enter the SETUP MODE. Refer to figure 2, on page 17.
7. Rotate the INPUT Control until "SETUP: Inputs, (Hold INPUT)" appears on the Information Display. Refer to figure 3, on page 17.
8. Press and hold in the INPUT Control until "SETUP: UNBAL 4, Off" appears on the Display. If necessary rotate the INPUT Control to select the UNBAL 4 Input. Refer to figure 6.
9. To switch the UNBAL 4 Input On, rotate the VOL-

UME Control until the display indicates "SETUP: UNBAL 4, On / Name".

10. Exit the SETUP Mode by several presses of the INPUT Control.

### RENAME INPUT:

In the following example, the BAL (BALANCED) Input will be renamed to match up with the component connected (refer to page 8, step 13).

The MA8900 Default Input Names (UNBAL 1, BAL, COAX 1, etc.) as indicated on the Front Panel Display can be customized to a different name up to ten characters long (TUNER, CD PLAYER, etc.). The available characters for renaming the input include the following: ! < > \* , / - \_ 0 1 2 3 4 5 6 7 8 9 A B C D E F G H I J K L M N O P Q R S T U V W X Y Z .

In the following example, the BAL Input will be renamed to "MEDIA SVR".

11. Press and hold in the INPUT Control to enter the SETUP MODE. Refer to figure 2, on page 17.
12. Rotate the INPUT Control until "SETUP: Inputs, (Hold INPUT)" appears on the Information Display. Refer to figure 7.



Figure 7

13. Press and hold in the INPUT Control until "SETUP: BAL, On / Rename" appears on the Display. If necessary rotate the INPUT Control to select the BAL Input. Refer to figure 8.

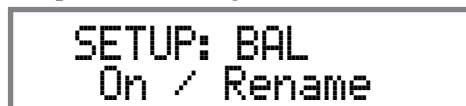

Figure 8

14. Press and hold in the INPUT Control until "RENAME: BAL, >BAL <" appears on the Display. The character "B" is flashing to indicate it is

ready to be changed. Refer to figure 9.



Figure 9

15. Rotate the VOLUME (ADJUST) Control to change the character "B" to "M". Refer to figure 10.



Figure 10

16. Rotate the INPUT Control until the character "A" is flashing, then rotate the VOLUME (ADJUST) Control to change the character "A" to "E". Refer to figure 11.



Figure 11

17. Rotate the INPUT Control until the character "L" is flashing, then rotate the VOLUME (ADJUST) Control to change the character "L" to "D". Refer to figure 12.



Figure 12

18. Rotate the INPUT Control until the "\_" empty space to the right of character D is flashing, then rotate the VOLUME (ADJUST) Control to change the "\_" empty space to character to "I". Refer to figure 13.



Figure 13

19. Rotate the INPUT Control until the “\_” empty space to the right of character I is flashing, then rotate the VOLUME (ADJUST) Control to change the “\_” empty space to character to “A”. Refer to figure 14.



Figure 14

20. Repeat step 19 until the new name of “RENAME: BAL, MEDIA SVR” is indicated on the Front Panel Display. Refer to figures 15 thru 17.



Figure 15



Figure 16



Figure 17

21. To save the new name, press and hold in the INPUT Control until “SETUP: MEDIA SVR, ON / Rename” appears on the Front Panel Information Display. Refer to figure 18.



Figure 18

22. Exit the SETUP Mode by several presses of the INPUT Control.

*Note: For convenience, an “Input Assignment Chart” on a separate sheet “Mc5A/5B” has been provided to keep track of changes.*

## Output Settings

The Output Settings provide the ability to change how the MA8900 Output 1, Output 2 and Headphones function.

### OUTPUT 1 and 2:

By default OUTPUT 1 and 2 are set to go On/Off by using the Front Panel OUTPUT 1 and 2 Push-buttons or by using the OUTPUT 1 and 2 Push-buttons on the Remote Control. If it is desirable to have OUTPUT 1 and/or 2 always On regardless of the OUTPUT 1 and 2 Push-button settings, perform the following:

1. Press and hold in the INPUT Control to enter the SETUP MODE. Refer to figure 2 on page 13.
2. Rotate the INPUT Control until “SETUP: Outputs, (Hold INPUT)” appears on the Information Display. Refer to figure 19.

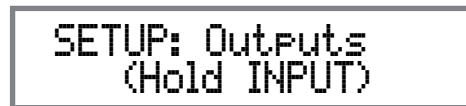

Figure 19

3. Press and hold in the INPUT Control until “SETUP: OUTPUT 1, Switched” appears on the Display. Refer to figure 20.

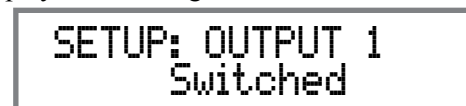

Figure 20

4. Rotate the VOLUME (ADJUST) Control to change from the “Switched” setting to “Unswitched”. Refer to figure 21.



Figure 21

5. In a similar manner, perform steps 3 and 4 to change the OUTPUT 2 setting. Refer to figures 22 and 23.



Figure 22



Figure 23

The MA8900 Default Setting for using Headphones is to automatically mute all the Output Connectors when the Headphone Cable Plug is inserted into the MA8900 Front Panel HEADPHONES Jack. There are two available settings:

- Mute All Outputs
- Mute No Outputs

6. Rotate the INPUT Control until “SETUP: HEADPHONES, Mute All Outputs” appears on the Information Display. Refer to figure 24.



Figure 24

7. Rotate the VOLUME (ADJUST) Control to change the current HEADPHONES setting from “Mute All Outputs” to “Mute No Outputs”. Refer to figure 25.



Figure 25

8. Exit the SETUP Mode by several presses of the INPUT Control.

## Power Control Triggers 1 and 2

By default the Power Control TRIGGER 1 and TRIGGER 2 are assigned to activate when Output 1 or Output 2 is selected. Triggers 1 and 2 can be reassigned to function the same as the MAIN Power Control Jack or be assigned to a given Input.

*Note: The MAIN Power Control Jack is controlled by the STANDBY/ON Front Panel Push-button and the Remote Control Power Push-buttons.*

In the first example, the Power Control Triggers 1 and 2 will be assigned to MAIN:

1. Press and hold in the INPUT Control to enter the SETUP MODE. Refer to figure 2 on page 17.
2. Rotate the INPUT Control until “SETUP: Triggers, (Hold INPUT)” appears on the Information Display. Refer to figure 26.

Figure 26

3. Press and hold in the INPUT Control until “SETUP: TRIGGER 1, Output 1” appears on the Display. Refer to figure 27.

Figure 27

4. Rotate the VOLUME (ADJUST) Control to select “MAIN” from the available additional selections including Output 2 or Input. Refer to figure 28.

Figure 28

5. In a similar manner, perform steps 3 and 4 to change the Trigger 2 setting from OUTPUT 2 to Main. Refer to figures 29 and 30.

Figure 29

Figure 30

In the second example, Trigger 2 will activate when the BAL Input is selected:

6. Rotate the INPUT Control to select “SETUP: TRIGGER 2, Main” appears on the Display. Refer to figure 30.
7. Rotate the VOLUME (ADJUST) Control until “SETUP: TRIGGER 2, Input (Hold INPUT)” appears on the Display. Refer to figure 31.

Figure 31

8. Press and hold in the INPUT Control until “SETUP: TRIGGER 2, Bal: OFF” appears on the Display. Refer to figure 32.

Figure 32

9. Rotate the VOLUME (ADJUST) Control to select “Bal : ON”. Refer to figure 33.

Figure 33

10. Exit the SETUP Mode by several presses of the INPUT Control.

## Data Ports

Data Port Connections between the MA8900 and a McIntosh Source Component allow for basic function control of the source component using the MA8900 supplied HR085 Remote Control. By default, all of the four Data Ports are set to send the same Data to the selected source. To dedicate a given Data Port for only one source component (example, source component connected to the BAL Input will be assigned to Data Port 1) perform the following Steps:

1. Press and hold in the INPUT Control to enter the SETUP MODE. Refer to figure 2 on page 17.
2. Rotate the INPUT Control until “SETUP: Data Ports, (Hold INPUT)” appears on the Information Display. Refer to figure 34.

Figure 34

3. Press and hold in the INPUT Control until “SETUP: DATA PORT 1, All Data” appears on the Display. Refer to figure 35.

Figure 35

4. Rotate the VOLUME (ADJUST) Control to select the “BAL” Input. Refer to figure 36.

Figure 36

5. In a similar manner, perform steps 3 and 4 to assign any additional Data ports.
6. Exit the SETUP Mode by several presses of the INPUT Control.



## Passthru

When the MA8900 is part of a Home Theater or Multichannel Audio System the Right and Left Front Channels from an Audio/Video Processor or Surround Decoder can “Passthru” from the assigned MA8900 Input, into the MA8900 Power Amplifier Circuitry. The “Passthru” Audio Signal is also available for a separate external Power Amplifier(s) via the number 1 Preamplifier Output Jacks. The Setup Mode allows selection of the specified MA8900 Input to be used for the Right and Left Front Channels. In the example below, the Right and Left Front Channels from the Audio/Video Processor will be connected to the UNBALANCED 6 INPUT Jacks on the MA8900. Refer to page 9 for additional connection information.

*Note: The Phono and Digital Inputs are not assignable as a Passthru Input.*

1. Press and hold in the INPUT Control to enter the SETUP MODE. Refer to figure 2 on page 17.
2. Rotate the INPUT Control until “SETUP: Passthru, Off” appears on the Information Display. Refer to figure 37.



SETUP: Passthru  
Off

Figure 37

3. Rotate the VOLUME (ADJUST) Control to select “SETUP: Passthru, UNBAL 6” Input. Refer to figure 38.



SETUP: Passthru  
UNBAL 6

Figure 38

4. Exit the SETUP Mode by several presses of the INPUT Control.

## USB Automute

The USB Automute Feature helps to ensure noise free playback of streaming music via the MA8900 USB Input, as the Digital Audio Signal format changes (PCM, DSD, etc.). On occasion due to the way a Digital Audio Music Recording was made, it may become desirable to switch Off the USB Automute Feature. To switch Off Automute, perform the following steps:

1. Press and hold in the INPUT Control to enter the SETUP MODE. Refer to figure 2 on page 17.
2. Rotate the INPUT Control until “SETUP: USB Automute, ON” appears on the Information Display. Refer to figure 39A.



SETUP: USB Automute  
ON

Figure 39A

3. Rotate the VOLUME (ADJUST) Control to select “SETUP: USB Automute, OFF” Input. Refer to figure 39B.



SETUP: USB Automute  
OFF

Figure 39B

4. Exit the SETUP Mode by several presses of the INPUT Control.

## Comm Port Baud Rate

The MA8900 may be remotely controlled from other equipment connected to the Rear Panel RS232 Jack. The speed at which the MA8900 communicates (8 bit, no parity and 1 stop bit) with other equipment is adjustable from 9,600 bits per second to 115,200 bits per second. To change from the default speed of 115,200 bits per second, perform the following steps:

1. Press and hold in the INPUT Control to enter the SETUP MODE. Refer to figure 2 on page 17.
2. Rotate the INPUT Control until “SETUP: RS232, 115200 Baud” appears on the Information Display. Refer to figure 40.



SETUP: RS232  
115200 Baud

Figure 40

3. Rotate the VOLUME (ADJUST) Control to select the desired Baud Rate Speed.
4. Exit the SETUP Mode by several presses of the INPUT Control.



## Remote Control Codes

The HR085 Remote Control included with the MA8900 utilizes the NORMAL McIntosh Control Codes. The Second Set of Control Codes the MA8900 will respond to is referred to as the ALTERNATE Codes. The Alternate Codes are used when the MA8900 is used in the same location as another McIntosh Preamplifier and/or A/V Processor. This will prevent the Remote Control from affecting the operation of both units at the same time. To activate the Remote Control ALTERNATE Codes perform the following steps:

1. Press and hold in the INPUT Control to enter the SETUP MODE. Refer to figure 2 on page 17.
2. Rotate the INPUT Control until “SETUP: IR Codes, Normal” appears on the Information Display. Refer to figure 41.

SETUP: IR Codes  
Normal

Figure 41

3. Rotate the VOLUME (ADJUST) Control to the Alternate Codes. Refer to figure 42.

SETUP: IR Codes  
Alternate

Figure 42

4. It is now necessary to change the HR085 Remote Control over to the Alternate Codes. Information on the HR085 Remote Control is available for download from the McIntosh Web Site:

<http://www.mcintoshlabs.com/us/Products/pages/ProductDetails.aspx?CatId=preamplifiers&ProductId=MA8900>

5. Exit the SETUP Mode by several presses of the INPUT Control.

## IR Sensor

The MA8900 Front Panel Sensor, which receives the signals from the HR085 Remote Control, can be switched off to prevent interference when an external IR Sensor is connected. To de-activate the Front Panel IR Sensor perform the following steps:

1. Press and hold in the INPUT Control to enter the SETUP MODE. Refer to figure 2 on page 17.
2. Rotate the INPUT Control until “SETUP: Front IR, Enabled” appears on the Information Display. Refer to figure 43.

SETUP: Front IR  
Enabled

Figure 43

3. Rotate the VOLUME (ADJUST) Control to select Disabled. Refer to figure 44.

SETUP: Front IR  
Disabled

Figure 44

5. Exit the SETUP Mode by several presses of the INPUT Control.

## Power Mode

The MA8900 incorporates an Auto Off Feature, which automatically places the preamplifier into the Power Saving Standby/Off Mode. This occurs approximately 30 minutes after there has been an absence of user activity (includes changes to any of the Operation Functions such as source selection, volume adjustment, etc.) or absence of an audio signal. If it is desirable to disable the Auto Off Feature perform the following steps:

1. Press and hold in the INPUT Control to enter the SETUP MODE. Refer to figure 2 on page 17.
2. Rotate the INPUT Control until “SETUP: Auto Off, Enabled” appears on the Information Display. Refer to figure 45.

SETUP: Auto Off  
Enabled

Figure 45

3. Rotate the VOLUME (ADJUST) Control to select Disabled. Refer to figure 46.

SETUP: Auto Off  
Disabled

Figure 46

4. Press the INPUT Control to exit the Setup Mode.

## Factory Reset

If it becomes desirable to reset all the adjustable settings (Setup and Trim Settings) to the factory default values, perform the following steps:

1. Press and hold in the INPUT Control to enter the SETUP MODE. Refer to figure 2 on page 17.
2. Rotate the INPUT Control until “FACTORY RESET, (Hold INPUT)” appears on the Information Display. Refer to figure 47.

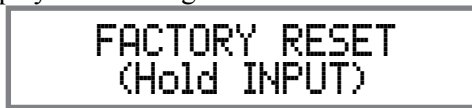

Figure 47

3. Press and hold in the INPUT Control until “FACTORY RESET, In Progress!” appears on the Information Display, then release the INPUT Control. Refer to figures 48 and 49.



Figure 48



Figure 49

4. Press the Front Panel STAND/BY Push-button to switch On the MA8900.

## Reset of the Microprocessors

### Reset of Microprocessors

In the unlikely event the controls of the MA8900 stop functioning, the microprocessors can be reset by performing the following:

1. Press the STANDBY/ON Push-button until the STANDBY/ON LED Indicator switches Off.
2. Then release the STANDBY/ON Push-button and the MA8900 will switch Off.
3. When the STANDBY/ON LED is illuminated press the STANDBY/ON Push-button, the MA8900 will resume normal operation.

*Note: This can be performed with the MA8900 On or in the Standby Mode.*





## How to Operate the MA8900

### Power On and Off



The Red LED above the STANDBY/ON Push-button lights to indicate the MA8900 is in Standby mode. To switch ON the MA8900, Press the STANDBY/ON Push-button on the Front Panel or press the  (Power - Green) Push-button on the Remote Control. The MA8900 will go through a brief startup initialization with the Front Panel Display indicating Power Guard is active, last used source and volume setting. This is followed by the volume setting indication starting at zero and then increasing to the last used volume setting. Refer to figures 50, 51, 52 and 53. To switch OFF the MA8900, press the STANDBY/ON Push-button on the Front Panel or the  (Power - Red) Push-button on the Remote Control.



Figure 51

*Note: For an explanation of the Remote Control Push-button functions, refer to pages 14 and 15.*



Figure 52

### Source Selection

Rotate the INPUT Control to select the desired source or press the INPUT Up▲ or Down▼ Push-button on the Remote Control. Refer to figures 50 and 53.

### Volume Control

Rotate the Front Panel VOLUME Control or use the VOLUME Up▲ or Down▼ Push-buttons on the Remote Control for the desired listening level. Refer to figures 50 and 53.

### Trim Functions

The MA8900 has various Trim Selections with Adjustments. The Trim Functions include Balance, Input Trim Level, Equalizer Mode, Phono Cartridge

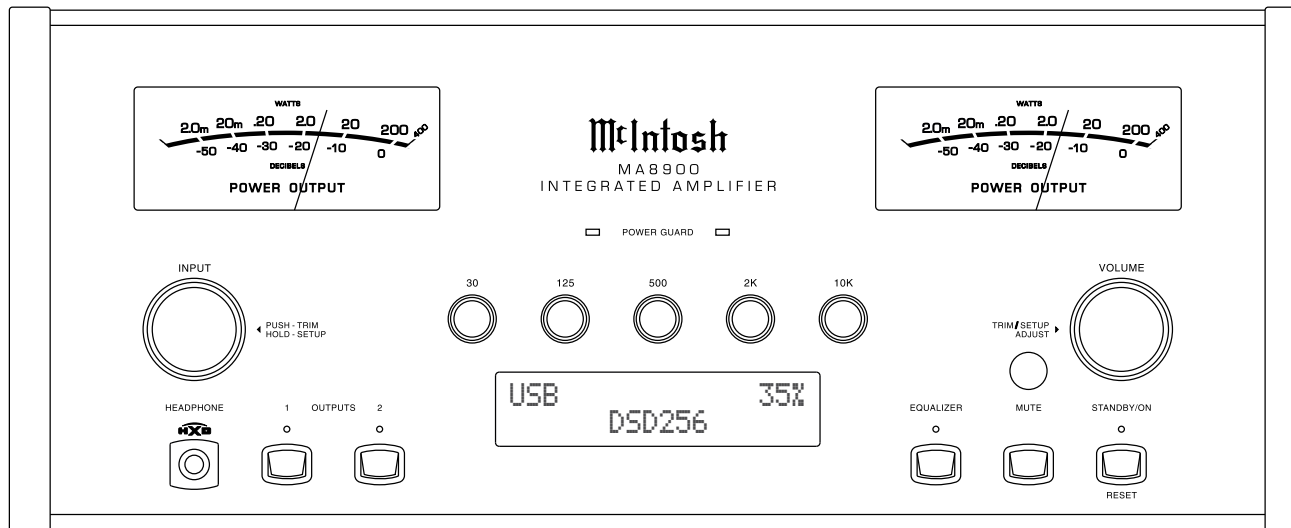

Figure 50

MC Loading (when the Input is Selected), Mono/Stereo, Meter Backlight, Display Brightness and HXD Mode (when Headphones are connected). The Trim Settings are stored in memory independently for each Input Source Selected, except the Meter Illumination which is the same for all inputs.

*Note: Selection and Adjustment of all Trim Functions may be performed by pressing the Front Panel INPUT Trim Control and then rotating it to select the desired Trim Function. Then use the VOLUME Adjust Control to change the setting. Remote Control TRIM Push-Button together with the LEVEL UP/Down Push-button may also be used. Refer to figures 50 and 53.*

After approximately 5 seconds the Display returns to indicate the Source Selection and Volume Level.

### BALANCE

Listening balance varies with different program sources, room acoustics and listening positions relative to the Loudspeakers. Use the Balance (Trim Function) as needed to achieve approximately equal listening volume levels in each

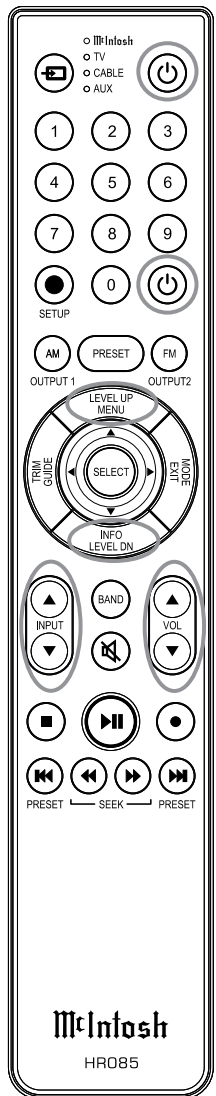

Figure 53

Loudspeaker. To adjust the Balance perform the following:

1. Press the TRIM Push-button repeatedly on the Remote Control until “L BALANCE R, ||” appears on the Front Panel Display. Refer to figure 54.



Figure 54

*Note: The Front Panel INPUT/Trim Control may also be used.*

2. Rotate the VOLUME/Adjust Control or press the LEVEL UP / DOWN Push-buttons on the Remote Control to emphasize the Right Channel (refer to figure 55) or the Left Channel (refer to figure 56).



Figure 55



Figure 56

The Front Panel Display indicates the relative Balance changes. After approximately 5 seconds, the Display returns to indicate the Source Selection and Volume Level. To verify the Balance setting without changing it, use the TRIM Push-button and select Balance.

### EQUALIZER MODE

The built-in five band Frequency Equalizer provides more precise adjustment of sound than Bass and Treble Controls. By default, the Equalizer is Off for all Input Sources and the Equalizer Circuitry is bypassed. Any Input Source may be assigned to have the Equal-

izer On when selected. To activate the Equalizer for a given Input Source, perform the following steps:

*Note: The audio signal present at the FIXED OUT Jacks is unaffected by the Equalizer settings.*

1. Select the desired Input Source.
2. Select “EQUALIZER, Off” as indicated on the Front Panel Information Display. Refer to figure 57.



Figure 57

3. Set the EQUALIZER On for the desired Input by using the Front Panel Volume Control or the Remote Control Push-buttons may also be used to switch the Equalizer On. Refer to figure 58.

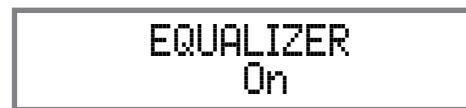

Figure 58

After approximately 5 seconds the Information Display returns to indicate the Source Selection and Volume Level.

### TRIM LEVEL

Source Components can have slightly different volume levels resulting in the need to readjust the MA8900 Volume Control when switching between different sources. The MA8900 allows the adjustment of levels for each Source, ensuring the same relative volume. To adjust the Trim Level for the currently selected Input Source perform the following steps:

1. Select “INPUT TRIM” as indicated on the Front Panel Information Display. Refer to figures 50, 53 and 59.

2. Adjust the Trim Level of each Input to match the average volume level of the Input most frequently listened to. The range of adjustment is  $\pm 6.0$ dB in half dB steps. Refer to figures 60 and 61.



Figure 59



Figure 60



Figure 61

After approximately 5 seconds the Information Display returns to indicate the Source Selection and Volume Level.

### PHONO ADJUSTMENTS

When the MC Phono Input is selected, an additional TRIM SELECT FUNCTION becomes available for adjustment. Perform the following steps to make the Phono Trim Adjustment:

1. Select the MC Phono Source Input.
2. Select TRIM “PHONO RESISTANCE, 400Ω” as indicated on the Front Panel Information Display. Refer to figure 62.



Figure 62

3. Rotate the VOLUME/Adjust Control or press the LEVEL UP / DOWN Push-buttons on the Remote Control to select the Resistance Load that comes



## How to Operate the MA8900, con't

closest to the Phono Cartridge Makers recommended value.

After approximately 5 seconds the Alphanumeric Display returns to indicate the Source Selection and Volume Level.

### MONO/STEREO MODE

By default the Stereo Mode is active for all Input Sources however, any Input Source may be assigned to Mono Mode. To change Stereo Mode to Mono for a given Input Source, perform the following steps:

*Note: The audio signal present at the FIXED OUT Jacks is affected by the Stereo/Mono setting.*

1. Select the desired Input Source.
2. Select "MONO / STEREO, \_\_\_\_\_" as indicated on the Front Panel Information Display. Refer to figure 63.



Figure 63

3. To select MONO Mode adjust the TRIM LEVEL. Refer to figure 64.



Figure 64

After approximately 5 seconds the Information Display returns to indicate the Source Selection and Volume Level.

### METER BACKLIGHT

The MA8900 Front Panel Meter Illumination may be switched On or Off by performing the following:

1. Select "METER LIGHTS, On" as indicated on the Front Panel Information Display. Refer to figures 50, 53 (on page 24) and 65.



Figure 65

2. Switch Off the Meter Illumination. Refer to figure 66.



Figure 66

After approximately 5 seconds the Information Display returns to indicate the Source Selection and Volume Level.

*Notes: 1. Meter Illumination of recent McIntosh Power Amplifiers will also switch On/Off when connected to the MA8900 via a power control cable.*

2. Some A/V Processors will provide an On/Off Control Signal when the MA8900 Passthru Input Jack is connected to the A/V Processor via the power control cable.

### INFORMATION DISPLAY ILLUMINATION

The Brightness Level of the MA8900 Front Panel Information Display can be adjusted from bright to dim by performing the following:

1. Select "DISPLAY BRIGHTNESS" as indicated on the Front Panel Information Display. Refer to figures 50, 53 (on page 24) and 67.



Figure 67

2. Reduce the Brightness level by adjusting the TRIM LEVEL. Refer to figure 68.



Figure 68

After approximately 5 seconds the Information

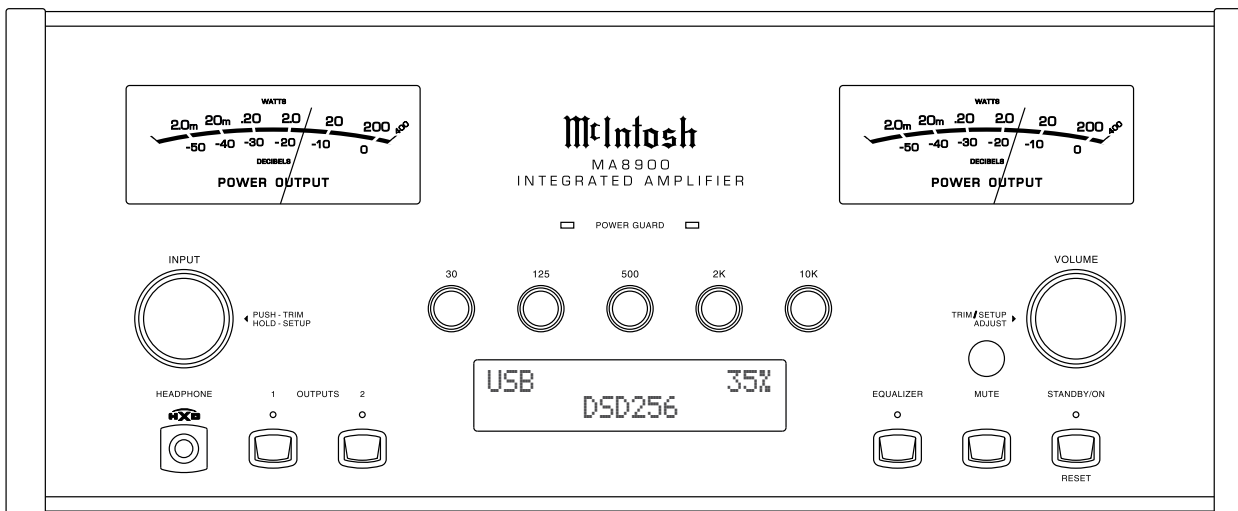

Figure 50



Display returns to indicate the Source Selection and Volume Level.

**HEADPHONE HXD**

When headphones are connected to the MA8900 Front Panel Jack, an additional TRIM function becomes available. McIntosh's HXD brings the acoustical depth and spatiality of music normally heard with loudspeakers, to your headphones. The default setting is HXD On. To switch HXD Off perform the following:

1. Momentarily press the INPUT Control, then rotate it to select "HEADPHONE HXD, On". Refer to figure 69.



Figure 69

2. To deactivate the HXD Mode rotate the VOLUME Adjust Control until the Front Panel Display indicates "HEADPHONE HXD, Off". Refer to figure 70.



Figure 70

**Equalizer**

Press the Front Panel EQUALIZER Push-button to activate the MA8900 Equalizer Control Circuitry for the currently selected Input Source. The LED above the EQUALIZER Push-button will illuminate. Refer to figure 50. The MA8900 remembers for each selected Input whether the Equalizer Control Circuitry is activated or deactivated. To deactivate the Equalizer Control Circuitry for the currently selected Input Source, press the EQUALIZER Push-button and the

LED above the push-button will extinguish.

- Note: 1. The audio signal present at the FIXED OUTPUT Jacks is unaffected by the Equalizer Circuitry.  
2. The EQUALIZER can also be accessed by the TRIM Function, refer to page 25.*

**Trim**

Press the Front Panel INPUT/TRIM Control to activate the MA8900 Trim Functions. Rotate the Front Panel INPUT/Trim Control to select the desired Trim Function and then rotate the VOLUME/Adjust Control to vary or make changes. Refer to figure 50. The Remote Control TRIM and LEVEL UP and LEVEL DOWN Push-buttons may also be used. Approximately 5 seconds after Trim Function Selection and/or adjustments have stopped, the MA8900 will switch off the Trim Mode.

**Mute**

Press the MUTE Push-button to Mute the Audio in Output 1 (Loudspeakers), Output 2 and Headphones. The audio signals present at the FIXED OUTPUT Jacks are not effected by activating the mute function. The Front Panel Display will indicate the Source Name and with the word MUTE in place of the actual volume setting. Refer to figure 71.



Figure 71

Pressing the Mute Push-button a second time or adjusting the volume control will un-mute the MA8900.

**Headphones Jack**

Connect a pair of dynamic headphones to the Headphone Jack with a 1/4" (0.635cm) stereo phone type

plug for private listening. The default setting is for Output Connections 1 and 2 to automatically mute. For additional Information refer to "HEADPHONE HXD" on this page.

*Note: The Headphone Output is optimized for impedances ranging from 100 to 600 ohms.*

**Power Output Meters**

The MA8900 Power Output Meters indicate the power delivered to the Loudspeakers. Refer to figure 72.

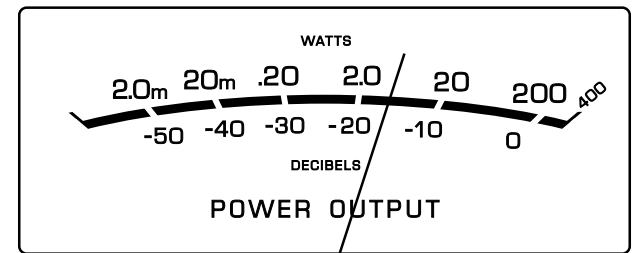

Figure 72

The meters respond to all the musical information being produced by the Amplifier. They indicate to an accuracy of at least 95% of the power output with only a single cycle of a 2,000Hz tone burst.

**Power Guard**

During normal operation, the Front Panel Power Guard Indicators will momentarily illuminate during peaks in the audio signals. In the event the MA8900 overheats, due to improper ventilation, high ambient temperature and/or impedance mismatch, the internal protection circuits will activate. The Front Panel Power Guard Indicators will continuously illuminate and the audio will be muted. When the MA8900 has returned to a safe operating temperature, normal operation will resume.



## How to Operate the MA8900, con't

### How To Make a Recording

1. Select the desired signal source you wish to record by using the Front Panel INPUT Control or the INPUT Up▲ or Down▼ Push-button on the Remote Control.
2. Adjust the record level using the recorder volume control and proceed with the recording process.
3. To listen to the playback of the program source just recorded select the Input the Recording Device is connected to.

*Note: The MA8900 FIXED OUTPUTS are not affected by the VOLUME, BALANCE or EQUALIZER-Controls Setting.*

### Using a Separate Power Amplifier

There are two different ways to use a separate power amplifier with a MA8900. The first way is to use the separate amplifier instead of the MA8900 built-in Power Amplifier. Connect the Loudspeakers to the separate Power Amplifier and remove the McIntosh Jumpers that are located between the OUTPUTS 1 Jacks and the PWR AMP INPUT Jacks. Refer to figure 73.

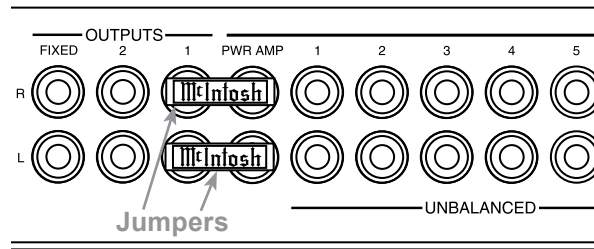

Figure 73

*Note: The McIntosh Jumpers must be connected, between the above mentioned jacks, when the MA8900 Internal Power Amplifier is to be used.*

The second way is to use both a separate Power Amplifier and the MA8900 built-in Power Amplifier. Connect one pair of Loudspeakers to the separate Power Amplifier and the second pair to the MA8900. Refer to the MA8900 Output Connection Diagrams located on the separate folded sheet “Mc2B” and figure 74.

*Note: The MA8900 VOLUME Control will affect the sound level of all the Loudspeakers.*

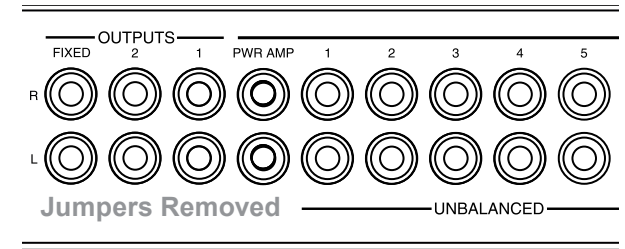

Figure 74

### Using Output 2

The MA8900 has provisions for connecting an external Power Amplifier (to drive Loudspeakers in another room) and an external sensor for remote operation of the MA8900 from that room. With an external Power Amplifier connected (as illustrated on the McIntosh Connection Diagram separate sheet “Mc2B”), press the Front Panel OUTPUT 2 Push-button or press on the Remote Control, the BLUE (Setup) Push-button followed by pressing the OUTPUT 2 Push-button to switch On or Off the external Power Amplifier.

### Passthru

When the MA8900 is connected together with a McIntosh Multichannel A/V Control Center or Surround Decoder and has the PASSTHRU Mode activated, it will automatically turn-on when the A/V Processor or Surround Decoder is turned On. It will indicate on the Front Panel Display “PASSTHRU”. Refer to figure 75.



Figure 75

The MA8900 OUTPUT 1 / OUTPUT 2 Front Panel Push-buttons are active when in the Passthru Mode. The other Front Panel Controls and Push-buttons are deactivated as long as the Passthru Mode is active.

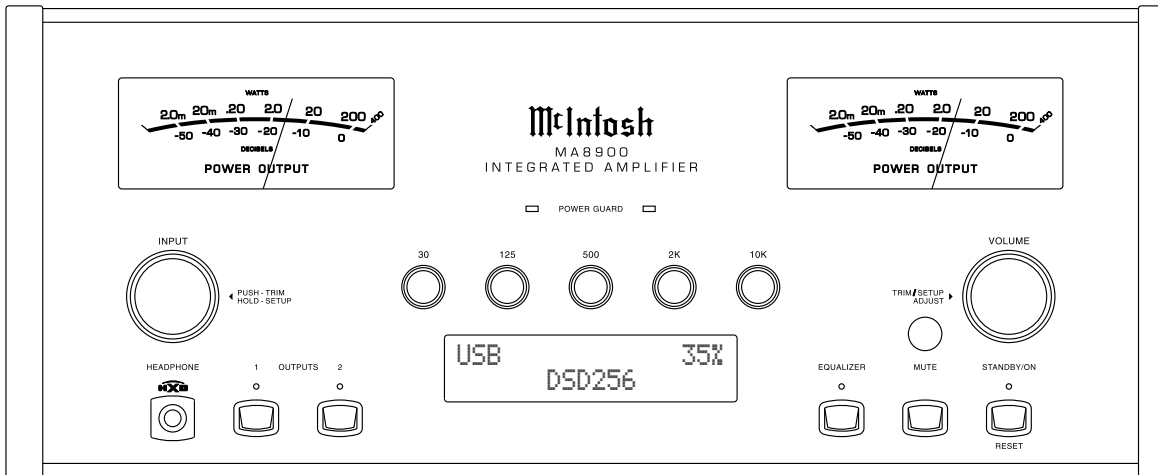

Figure 50

**Equalizer Controls**

The MA8900 Equalizer has five Frequency Controls which will raise or lower by 12dB, the amplitude of the band of frequencies centered at the frequency marked above the controls. The center frequencies of these controls are at 30Hz, 125Hz, 500Hz, 2,000Hz and 10,000Hz. Both Left and Right Channels are affected. At the center detent or flat position of the controls, the tone circuit components are removed from the signal path.

The illustration to the right shows the fundamental frequency range of acoustical musical instruments and the human voice. It also shows the range of adjustment of frequencies for each of the Equalizer Controls of the MA8900 at the +6dB and -6dB points.

**Optical and Coaxial Digital Inputs**

When a Digital Input (Optical or Coaxial Connection) on the MA8900 is selected, the Front Panel Display will indicate the sample rate when a signal is present "48kHz". Refer to figure 76.



Figure 76

During the time there is no Digital Signal present on the selected input the display will indicate "-----". Refer to figure 77.

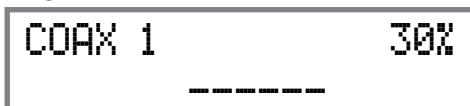
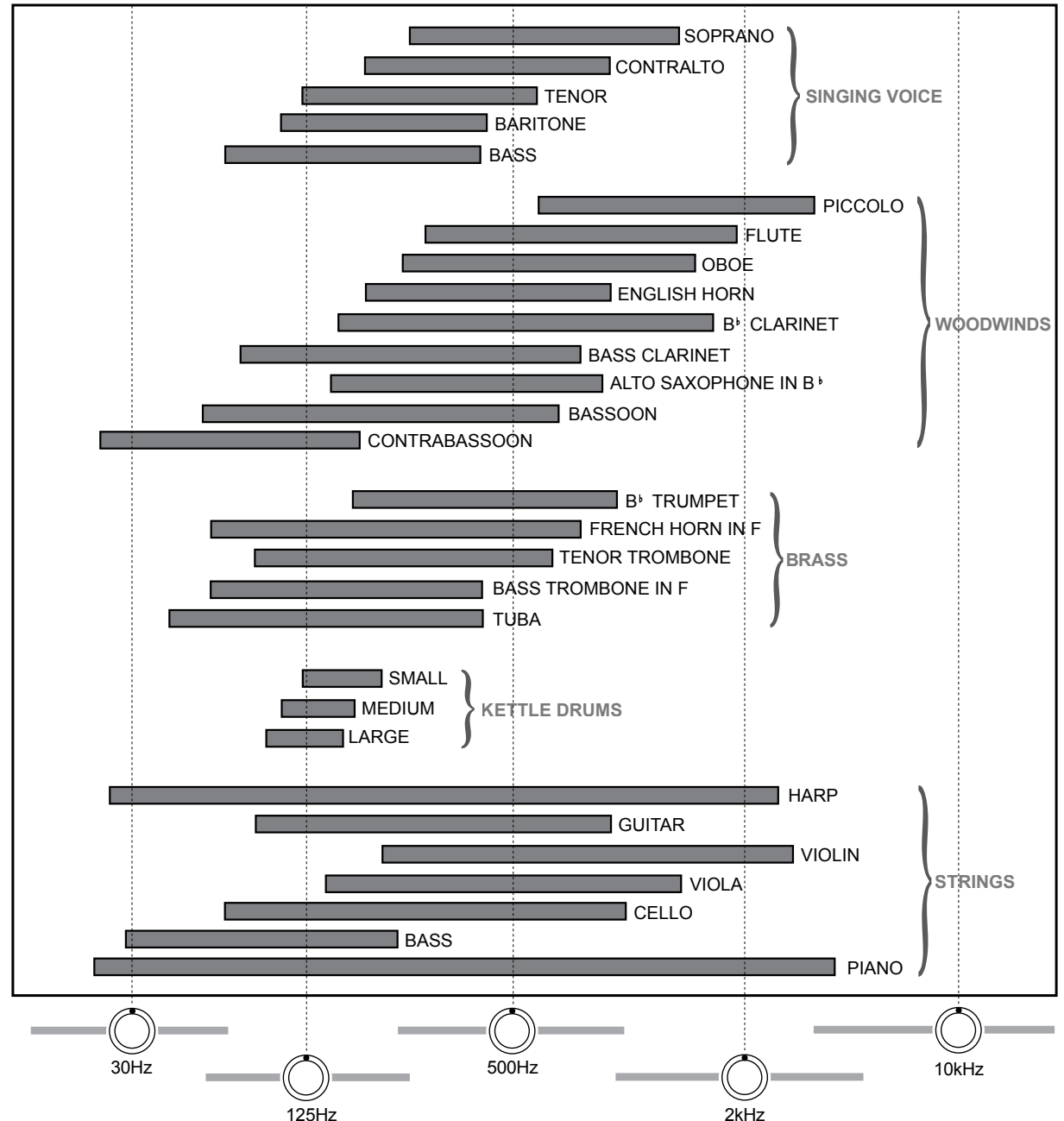

Figure 77

**Fundamental Frequencies of Acoustical Musical Instruments and the Human Voice**





## How to Operate the MA8900, con't

### USB Input Operation and Driver Installation

The MA8900 USB Input provides the capability to playback music from a computer, when the computer is connected to the rear panel USB connector.

*Note: The USB Input is for direct connection to a computer only. To playback music from an USB Drive, connect the USB Drive to another USB Port on the computer and select the USB Drive with the Media Playback Program.*

The MA8900 USB Input is compatible with PC Computers using Microsoft®, Windows 7 (SP1), Windows 8.1 and Windows 10. It is also compatible with Apple® Macintosh® Computers using OS-10.6.8 or later.

When using a PC Computer with Windows, a special McIntosh USB Audio Software Driver needs to be installed on the PC Computer. The driver needs to be installed before connecting the MA8900 USB Input to the USB Port on the computer.

*Note: If an Apple Macintosh computer is used with the MA8900, no additional driver is required.*

The McIntosh USB Audio Windows Driver is available for download from the McIntosh Web Site:

<http://www.mcintoshlabs.com/us/Support/Pages/Manuals.aspx>

Under “PRODUCT CATEGORY” select “Pre-amplifiers” then under “MODEL NUMBER” select “MA8900”. Click on “SEARCH” then select “McIntosh-HD USB Audio Windows Drive v1.0” and download the PC Windows Driver. Follow the instructions below to install the McIntosh MA8900 Driver:

**Purpose:** To Install the McIntosh USB Audio Windows Driver for use with McIntosh Products with an USB-Digital Audio Input.

- Requirements:**
1. A PC Computer with a functioning USB Port.
  2. Windows 7 (SP1 or greater), Windows 8 (8.1) or Windows 10 Operating System.
  3. An USB Cable with Type A to Type B Connectors.

### Installing the Software

It is important to first install the downloaded software on your computer before connecting the McIntosh Product to the computer. The USB Driver is included in the downloaded software package.

*Note: Before installing this software, please check to see if the McIntosh Product(s) with the USB-Digital Audio Input has the latest firmware version, if not update the firmware first.*

1. Unzip the downloaded McIntosh Windows USB Driver Software Package.
2. Run “McIntoshHDSwPkg\_20150814\_v1p9p110p2.zip”. Refer to figures 90 thru 97.

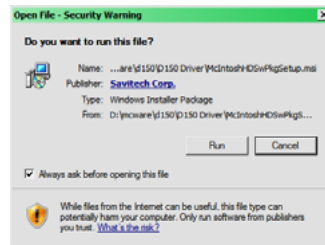

Figure 90

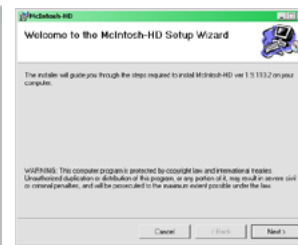

Figure 91

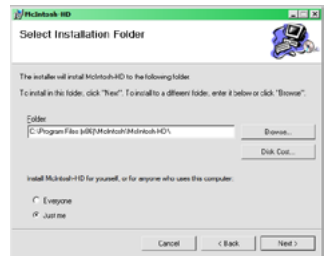

Figure 92

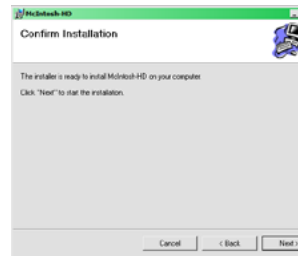

Figure 93

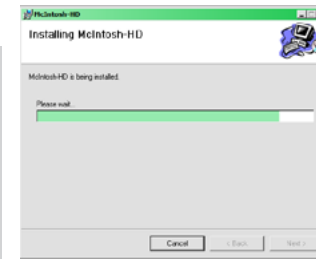

Figure 94

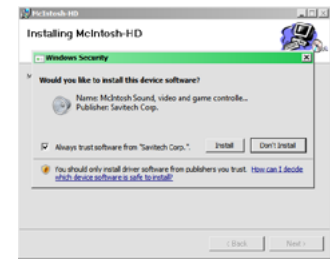

Figure 95

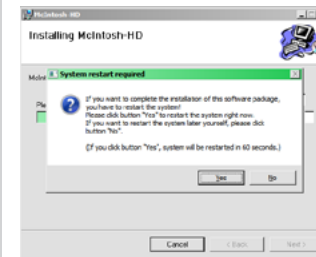

Figure 96

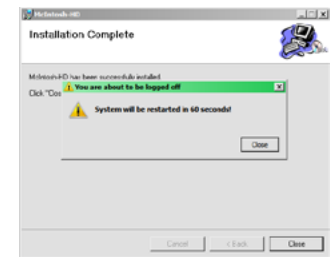

Figure 97

3. When the Windows Security window appears check the *Always trust software from “Savitech Corp.”* box and then the Install button. When the software has been installed, it is necessary to reboot the computer. Refer to figure 96.

After rebooting, a McIntosh-HD icon will appear on the desktop. Refer to figure 98.



Figure 98

### USB Connection

Connect the USB Cable with Type A to Type B connectors between the PC Computer and the McIntosh Product with the USB-Digital Audio Input. An Icon will appear On-Screen indicating Windows has found new hardware. Refer to figure 99.

Upon completion of installing the driver, figure 100 will appear.

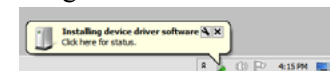

Figure 99

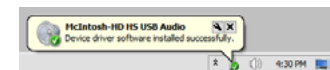

Figure 100



### Windows Sound Settings

For proper operation of the McIntosh Product via the Computer USB Connection, it is required to make changes to Windows Sound Settings:

1. From the Windows START button, click on "CONTROL PANEL" followed by selecting "SOUND". Refer to figure 101.
2. Referring to figure 102, first select "McIntosh-HD HS USB Audio" and then click on the "Set Default" button.



Figure 101

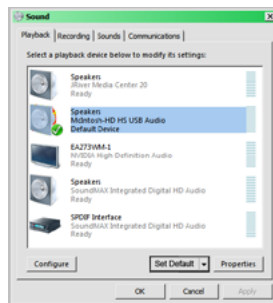

Figure 102

*Notes: 1. When the McIntosh USB Audio Product is not connected to your computer, the previous default Audio Device will be selected.*

2. If other McIntosh Products with USB Audio Connections are also connected to the computer, an additional "McIntosh USB Audio" playback device will appear in the listing. Make sure to select the "McIntosh-HD HS USB Audio" from available playback devices listed when using this McIntosh Product for USB Audio.

### Control Panel Settings

To activate the McIntosh-HD USB Audio Control Panel Click on the "McIntosh Icon" (located in the Windows notification area on the right side of the taskbar)

or Click on the Windows "Show hidden icons", then Select the "McIntosh Icon". Refer to figures 103 and 104.

*Notes: 1. It is not necessary for the McIntosh-HD USB Audio Control Panel to be running, unless it is desired to make changes to the default settings.*

2. The McIntosh-HD USB Audio Control Panel displays the current Sampling Rate, Bit-Rate and Buffer Size for the music streaming from the computer into the MA8900.

3. When the Media Stream Program on the computer is set to output in the "ASIO" format, the McIntosh -HD USB Audio Control Panel allows for changing the settings parameters on the fly.

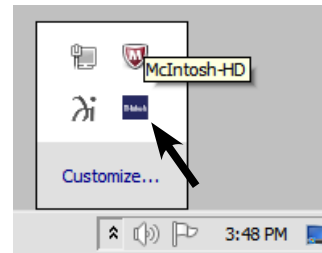

Figure 103



Figure 104

### USB Music Playback

When the USB Input is selected on the McIntosh MA8900, the Front Panel Display indicates the

Sampling Rate (refer to figures 105 and 106 for PCM Signals).



Figure 105

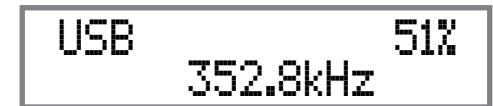

Figure 106

Figures 107 and 108 indicate a Sampling Rate of 128 or 256 times the Sampling Rate of a CD Disc for the incoming DSD Digital Audio Signal.



Figure 107



Figure 108

The Sampling Rate and the Bit Rate are determined by the original recording, the Application Output Format (when available) and the McIntosh-HD Control Panel Settings.

*Note: In general, when the original music is recorded at a higher Sampling Rate, the result is usually more detail in the music. However, this higher rate results in consuming larger amounts of storage space. The Sample Rate usually should be set to match the Sample Rate of the music recording being played back.*

There are many third party Applications (besides Applications like Windows Media Player) for steaming music from the computer to McIntosh MA8900 USB Input. An example of just one of the available applications is "JRiver Media Center".





**Amplifier Specifications**

**Power Output**

200 watts is the minimum sine wave continuous average power output per channel, both channels operating

**Output Load Impedance**

2, 4 or 8 ohms

**Rated Power Band**

20Hz to 20,000Hz

**Total Harmonic Distortion**

0.005% maximum with both channels operating from 250 milliwatts to rated power, 20Hz to 20,000Hz

**Intermodulation Distortion**

0.005% maximum, if the instantaneous peak power is 400 watts or less per channel with both channels operating for any combination of frequencies from 20Hz to 20,000Hz

**Dynamic Headroom**

2.0dB

**Wide Band Damping Factor**

Greater than 40

**Power Guard**

Less than 2% THD with up to 16dB overdrive at 1,000Hz

**Frequency Response**

+0, -0.5dB from 20Hz to 20,000Hz  
+0, -3dB from 10Hz to 100,000Hz

**Preamplifier Output 1 and 2 (for rated input)**

1.4V unbalanced (8V Maximun)

**Sensitivity (for rated output)**

High Level, 250mV unbalanced, 500mV balanced  
Phono MM, 2.5mV  
Phono MC, 0.25mV  
Power Amp In, 1.4V

**Signal To Noise Ratio (A-Weighted)**

High Level, 95dB below rated output  
Phono MM, 82dB below 5mV input  
Phono MC, 80dB below 0.5mV input  
Power Amplifier, 113dB below rated output

**Input Impedance**

High Level, 20K ohms  
Phono MM - 47K ohms; 50pF  
Phono MC - 50, 100, 200, 400 or 1,000 ohms; 100pF

**Preamplifier Output Impedance**

220 ohms

**Equalizer Controls**

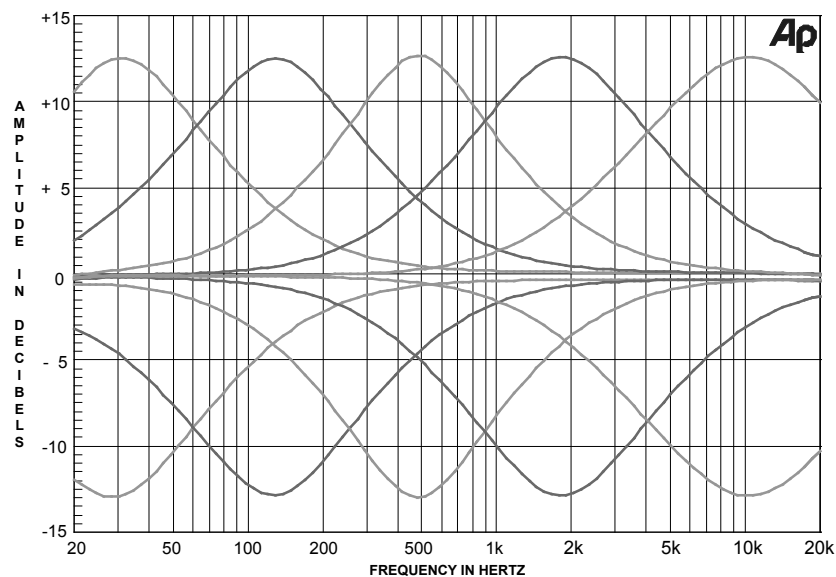

**Maximum Input Signal**

High Level, 8V unbalanced, 16V balanced  
Phono MM, 80mV  
Phono MC, 8mV  
Power Amplifier In, 16V

**Preamplifier Output Impedance**

220 ohms

**Headphone Impedance**

100 to 600 ohms

**Voltage Gain**

High Level to Rec Output: 0dB  
High Level to Output 1 and 2: 15dB  
Phono MM to Rec Output: 40dB  
Phono MC to Rec Output: 60dB  
Phono MM to Output 1 and 2: 55dB  
Phono MC to Output 1 and 2: 75dB  
Power Amplifier: 29dB

**Power Control and Trigger Output**

12VDC, 25mA



## Digital Audio Specifications

### Digital Input Signal Format

Coaxial and Optical Inputs - SPDIF (PCM)  
MCT and USB Inputs - PCM, DSD

### Digital Input Sample Rate

Coaxial and Optical: 44.1kHz to 192kHz, 24-Bit  
MCT: 44.1kHz, 16-Bit (CD)  
DSD64 (SACD)  
USB: 44.1kHz to 384kHz, 32-Bit (PCM)  
DSD64, DSD128, DSD256,  
DXD352.8kHz, DXD384kHz

### Digital Inputs

Coaxial: 0.5V p-p/75 ohms  
Optical: -15dbm to -21dbm (TOS Link)  
MCT: 0.5V p-p/75 ohms  
USB: USB Type B Connector

## General Specifications

### Power Requirements

*Field AC Voltage conversion of the MA8900 is not possible. The MA8900 is factory configured for one of the following AC Voltages:*

100 Volts, 50/60Hz at 5.2 amps  
110 Volts, 50/60Hz at 4.4 amps  
120 Volts, 50/60Hz at 4.4 amps  
220 Volts, 50/60Hz at 2.45 amps  
230 Volts, 50/60Hz at 2.35 amps  
240 Volts, 50/60Hz at 2.25 amps  
Standby: Less than 0.25 watt

*Note: Refer to the rear panel of the MA8900 for the correct voltage.*

### Overall Dimensions

Width is 17-1/2 inches (44.45cm)  
Height is 7-5/8 inches (19.37cm) including feet  
Depth is 22 inches (55.88cm) including the Front Panel, Knobs and Cables

### Weight

75 pounds (34.1 kg) net, 93 pounds (42.3 kg) in shipping carton

### Shipping Carton Dimensions

Width is 29-1/2 inches (74.93cm)  
Depth is 29 inches (73.66cm)  
Height is 17 inches (43.18cm)

**Packing Instructions**

In the event it is necessary to repack the equipment for shipment, the equipment must be packed exactly as shown below. It is very important that the four plastic feet are attached to the bottom of the equipment. Two #10 x 2-1/2 inch screws and washers must be used to fasten the unit securely to the bottom pad and wood skid. This will ensure the proper equipment location on the bottom pad. Failure to do this will result in shipping damage. Use the original shipping carton and interior parts only if they are all in good serviceable condition. If a shipping carton or any of the interior part(s) are needed, please call or write Customer Service Department of McIntosh Laboratory. Refer to page 2. Please see the Part List for the correct part numbers.

**MA8900 Packing Material List**

Quantity	Part Number	Description
1	033888	Shipping carton
4	033887	End Cap
1	033697	Inner carton
1	033725	Top pad
1	034576	Bottom pad
1	034480	Wood skid
2	017218	Plastic foot (spacer)
2	401204	#10 x 2-1/2 inch wood screw
2	404033	#10 flat washer 1-3/4 inch
4	017937	Plastic foot
4	400159	#10-32 x 3/4 machine screw
4	404080	#10 flat washer

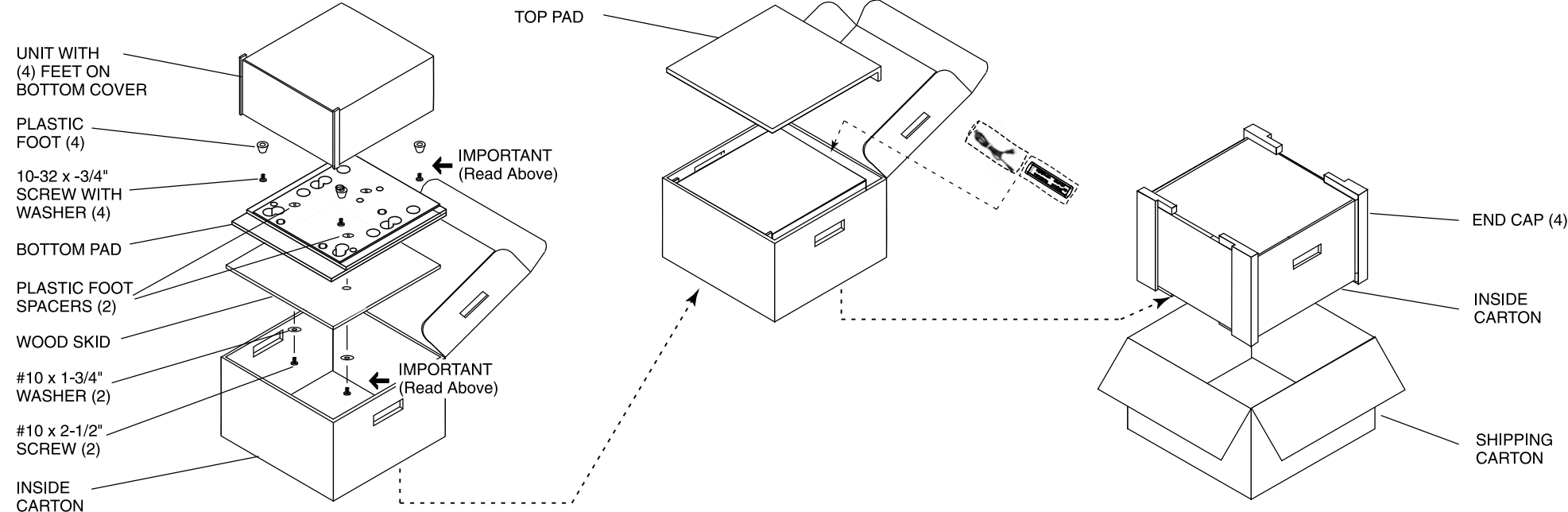



McIntosh Laboratory, Inc.  
2 Chambers Street  
Binghamton, NY 13903  
[www.mcintoshlabs.com](http://www.mcintoshlabs.com)

The continuous improvement of its products is the policy of McIntosh Laboratory Incorporated who reserve the right to improve design without notice.  
Printed in the U.S.A.