



McIntosh Laboratory, Inc. 2 Chambers Street Binghamton, New York 13903-2699 Phone: 607-723-3512 www.mcintoshlabs.com

C47
Audio Preamplifier
Owner's Manual



The lightning flash with arrowhead, within an equilateral triangle, is intended to alert the user to the presence of uninsulated "dangerous voltage" within the product's enclosure that may be of sufficient magnitude to constitute a risk of electric shock to persons.

WARNING - TO REDUCE RISK OF FIRE OR ELECTRICAL SHOCK, DO NOT EXPOSE THIS EQUIPMENT TO RAIN OR MOISTURE.

IMPORTANT SAFETY INSTRUCTIONS!

PLEASE READ THEM BEFORE OPERATING THIS EQUIPMENT.

1. Read these instructions.
2. Keep these instructions.
3. Heed all warnings.
4. Follow all instructions.
5. Do not use this apparatus near water.
6. Clean only with a dry cloth.
7. Do not block any ventilation openings. Install in accordance with the manufacturer's instructions.
8. Do not install near any heat sources such as radiators, heat registers, stoves, or other apparatus (including amplifiers) that produce heat.
9. Do not defeat the safety purpose of the polarized or grounding-type plug. A polarized plug has two blades with one wider than the other. A grounding type plug has two blades and a third grounding prong. The wide blade or the third prong are provided for your safety. If the provided plug does not fit into your outlet, consult an electrician for replacement of the obsolete outlet.
10. Protect the power cord from being walked on or pinched particularly at plugs, convenience receptacles, and the point where they exit from the apparatus.
11. Only use attachments/accessories specified by the manufacturer.
12. Use only with the cart, stand, tripod, bracket, or table specified by the manufacturer, or sold with the apparatus. When a cart is used, use



ATTENTION:
RISQUE DE CHOC ELECTRIQUE - NE PAS OUVRIR
NO USER-SERVICEABLE PARTS INSIDE. REFER SERVICING TO QUALIFIED PERSONNEL.

- caution when moving the cart/apparatus combination to avoid injury from tip-over.
13. Unplug this apparatus during lightning storms or when unused for long periods of time.
 14. Refer all servicing to qualified service personnel. Servicing is required when the apparatus has been damaged in any way, such as power-supply cord or plug is damaged, liquid has been spilled or objects have fallen into the apparatus, the apparatus has been exposed to rain or moisture, does not operate normally, or has been dropped.
 15. Do not expose this equipment to dripping or splashing and ensure that no objects filled with liquids, such as vases, are placed on the equipment.
Ne pas exposer cet appareil à des éclaboussures ou gouttelettes d'un liquide. Aucun objet remplie de liquide comme par exemple un vase ne doit être placé sur l'appareil.
 16. If this equipment is supplied with a power supply cord only, the mains plug of the power supply cord shall remain readily operable. To completely disconnect this equipment from the a.c. mains remove the plug from the a.c. receptacle.
Si l'équipement est uniquement alimenté par un cordon d'alimentation, la fiche du cordon d'alimentation doit demeurer aisément accessible. Pour déconnecter complètement l'équipement du réseau d'alimentation, déconnecter la fiche du cordon d'alimentation de la prise murale.

The exclamation point within an equilateral triangle is intended to alert the user to the presence of important operating and maintenance (servicing) instructions in the literature accompanying the appliance.

To prevent the risk of electric shock, do not remove cover or back. No user-serviceable parts inside.

17. If this equipment is supplied with AC /DC Adapter with separate power supply cord or the AC/DC Adapter plugging directly into an a.c. receptacle, they shall remain readily operable. To completely disconnect this equipment from the a.c. mains remove the AC /DC Adapter mains power supply cord from the a.c. receptacle or remove the AC /DC Adapter when it is directly plugged into the a.c. receptacle.
Si l'équipement est alimenté par un adaptateur AC/DC munis d'un cordon d'alimentation ou un adaptateur AC/DC qui est alimenté directement à la prise murale, ils doivent demeurer aisément accessibles. Pour déconnecter complètement l'équipement du réseau d'alimentation, déconnecter l'adaptateur AC/DC de la prise murale ou déconnecter le cordon d'alimentation de l'adaptateur AC/DC de la prise murale.
18. **WARNING:** Do not expose batteries or battery pack to excessive heat such as sunshine, fire or the like.
AVERTISSEMENT: Les batteries ou bloc de batteries ne doivent pas être exposées à une chaleur excessive telle que celle du soleil, feu ou autre source de chaleur similaire.
19. **CAUTION:** danger of explosion if battery is incorrectly replaced. Replace only with the same or equivalent type.
ATTENTION: danger d'explosion si la pile n'est pas remplacée correctement. Ne remplacer que par le même type ou un type équivalent.
20. Connect mains power supply cord only to a mains socket outlet with a protective earthing connection.

Thank You

Your decision to own this McIntosh C47 Audio Pre-amplifier ranks you at the very top among discriminating music listeners. You now have “The Best.” The McIntosh dedication to “Quality,” is assurance that you will receive many years of musical enjoyment from this unit.

Please take a short time to read the information in this manual. We want you to be as familiar as possible with all the features and functions of your new McIntosh.

Please Take A Moment

The serial number, purchase date and McIntosh Dealer name are important to you for possible insurance claim or future service. The spaces below have been provided for you to record that information:

Serial Number: _____

Purchase Date: _____

Dealer Name: _____

Technical Assistance

If at any time you have questions about your McIntosh product, contact your McIntosh Dealer who is familiar with your McIntosh equipment and any other brands that may be part of your system. If you or your Dealer wish additional help concerning a suspected problem, you can receive technical assistance for all McIntosh products at:

McIntosh Laboratory, Inc.
2 Chambers Street
Binghamton, New York 13903
Phone: 607-723-3512
Fax: 607-724-0549

Customer Service

If it is determined that your McIntosh product is in need of repair, you can return it to your Dealer. You can also return it to the McIntosh Laboratory Service Department. For assistance on factory repair return procedure, contact the McIntosh Service Department at:

McIntosh Laboratory, Inc.
2 Chambers Street
Binghamton, New York 13903
Phone: 607-723-3515
Fax: 607-723-1917

Table of Contents

Safety Instructions	2
Thank You and Please Take a Moment.....	3
Technical Assistance and Customer Service	3
Table of Contents	3
General Information	4
Connector and Cable Information	4
Introduction.....	5
Performance Features	5
Dimensions	6
Installation	7

Connections:

Rear Panel Connections, Connecting Components .	8-9
Rear Panel Connections (Separate Sheet).....	Mc2B
Connecting Components (Separate Sheets).....	Mc1A,
.....	Mc1B, Mc2A
Input Assignment Chart (Separate Sheet).....	Mc5A,
.....	Mc5B

Remote Control:

HR085 Remote Control Push-buttons	10
How to use the HR085 Remote Control	11

Front Panel:

Front Panel Displays, Controls, Push-buttons and Jack.....	12
--	----

Setup:

How to Operate the Setup Mode	13
Default Settings.....	13
Firmware Version.....	13
Input Settings	13
Rename Input	14
Output Settings	15
Power Control Triggers 1 and 2	16
Data Ports.....	16
Passthru.....	17
Comm Port Baud Rate	16
Remote Control Codes.....	17
IR Sensor, Power Mode and Factory Reset	18

Operation:

How to Operate the C47	20
Trim Functions.....	20-22
Mute	23
Outputs 1&2, Trim, Output Meters and Passthru.....	23
Headphone Jack and How to make a Recording.....	24
Optical and Digital Inputs.....	25
USB Input and Installing Software.....	25-26
USB Music Playback.....	25
Reset of Microprocessors.....	24

Additional Information:

Photos.....	24-25
Specifications.....	26
Packing Instruction.....	27

Copyright 2015 © by McIntosh Laboratory, Inc.

General Information

- For additional connection information, refer to the owner's manual(s) for any component(s) connected to the C47 Audio Preamplifier.
- The Main AC Power going to the C47 and any other McIntosh Component(s) should not be applied until all the system components are connected together. Failure to do so could result in malfunctioning of some or all of the system's normal operations. When the C47 and other McIntosh Components are in their Standby Power Off Mode, the Microprocessor's Circuitry inside each component is active and communication is occurring between them.
- Balanced and Unbalanced Inputs and Outputs can be mixed. For example, you may connect signal sources to Unbalanced Inputs and send signals from the Balanced Outputs. You can also use Balanced and Unbalanced Outputs simultaneously, connected to different Power Amplifiers.
- The C47 internal Digital to Analog Converter Circuitry is designed to decode 2-channel PCM (Pulse Code Modulation) and DSD (Direct Stream Digital) Digital Signals. The Coaxial and Optical Digital Audio Inputs are for PCM Digital Signals. The Digital DIN and USB Audio Inputs are for PCM and DSD Digital Signals. Other Digital Audio Signal Format Types will cause the Audio Outputs of the C47 to be muted and the Front Panel Information Display will indicate an error message.
- Sound Intensity is measured in units called Decibels and "dB" is the abbreviation.
- The McIntosh C47 is factory configured for immediate use. It can also be customized to complement the components making up your system. Refer to the C47 "Setup Mode" starting on page 13 for additional information.

- The Remote Control Supplied with the C47 Preamplifier is capable of operating other components. For additional information go to www.mcintoshlabs.com.
- The IR Input, with a 3.5mm mini phone jack, is configured for non-McIntosh IR sensors such as a Xantech Model HL85BK Kit. Use a Connection Block such as a Xantech Model ZC21 when two or more IR sensors need to be connected to the C47. The signal from a connected External IR Sensor will have priority over the signal from the Front Panel IR Sensor.
- When discarding the unit, comply with local rules or regulations. Batteries should never be thrown away or incinerated but disposed of in accordance with the local regulations concerning battery disposal. 
- For additional information on the C47 and other McIntosh Products please visit the McIntosh Web Site at www.mcintoshlabs.com.

Connector and Cable Information

XLR Connectors

Below is the Pin configuration for the XLR Balanced Input and Output Connectors on the C47. Refer to the diagrams for connections:

- PIN 1: Shield/Ground
- PIN 2: + Output
- PIN 3: - Output

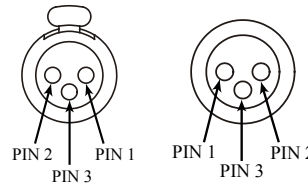

Power Control and Trigger Connectors

The C47 Power Control Out, Trigger and PASSTHRU Output Jacks send Power On/Off Signals (+12 volt/0 volt) when connected to other McIntosh Components. An additional connection is for controlling the illumina-

tion of the Power Output Meters on McIntosh Power Amplifiers. A 3.5mm stereo mini phone plug is used for connection to the Power Control, Trigger and PASSTHRU Outputs on the C47.

*Note: The Power Control, Trigger, PASSTHRU and Data Connecting Cable is available from the McIntosh Parts Department: **Power Control, Trigger, PASSTHRU and Data Cable Part No. 170-202** Six foot, shielded 2 conductor, with 3.5mm stereo mini phone plugs on each end.*

Main, Triggers 1-4 and PASSTHRU

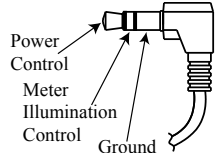

Data Port Connectors

The C47 Data Out Ports send Remote Control Signals to Source Components. A 3.5mm stereo mini phone plug is used for connection.

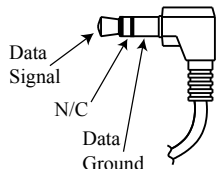

IR IN Port Connectors

The IR IN Port also uses a 3.5mm stereo mini phone plug and allows the connection of other brand IR Receivers to the C47.

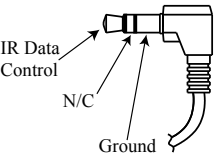

RS232 Data Port Cable

The RS232 Data Cable is a 3.5mm stereo mini phone plug to a subminiature DB 9 connector:

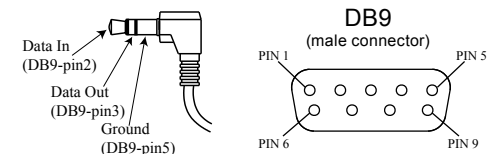

Introduction

The McIntosh C47 Audio Preamplifier is one of the finest Preamplifiers ever created with connections for both analog and digital sources. The C47 Outputs have the ability to drive multiple Power Amplifiers. The C47 reproduction is sonically transparent and absolutely accurate. The McIntosh Sound is “The Sound of the Music Itself.”

Performance Features

• **Electromagnetic Input Switching with Level Trim Adjustment**

Digital Logic Circuits drive Electromagnetic Switches on all Inputs and operating functions for reliable, noiseless, distortion free switching. The Analog Inputs can be matched in level, preventing abrupt changes in volume levels.

• **Moving Coil and Moving Magnet Phono Inputs**

The C47 has two precision Phono Preamplifier Circuits, one for Moving Coil Phono Cartridges and the other for Moving Magnet Cartridges. Both phono inputs have selectable loading. The circuits use the latest designs providing the lowest possible noise and distortion. The close tolerance resistors and capacitors used in the RIAA Correction Equalization Circuitry provides an extremely flat frequency response.

• **Digital Audio Inputs**

The Digital Inputs decode PCM and DSD Signals from external sources. Coaxial and Optical Inputs process Digital Signals up to 192kHz with 24-Bit resolution. The Digital MCT Input Circuitry directly decodes SACD/CD signals from an external Transport component. The USB Input for streaming audio processes Digital Signals up to 384kHz with 32Bit resolution, decodes up to DSD256 Digital Signals and DXD 24Bit with a sampling rate up to 384kHz.

• **Balanced Inputs**

The Balanced Inputs allow the connection of a source component using long cable lengths without a loss in sound quality.

• **Precision Tracking Volume Control**

Volume levels are controlled by a Precision Balanced Digitally Controlled Attenuator System with an Optical Encoder Rotary Control. This assures a 0.1dB tracking accuracy between channels. There are 214 individual 0.5dB volume level steps with no noise as the volume level is changed.

• **Variable Rate Volume and Balance Controls**

The C47 Preamplifier’s Volume and Balance Control Circuitry provides an ideal rate of change with control rotation.

• **Tone Controls**

The Bass and Treble Trim Controls provide up to 12dB of boost or cut. The C47 remembers the Bass and Treble Setting for each input.

• **HXD® for Headphones**

The C47 Headphone Crossfeed Director Circuitry (HXD®) improves the sound localization for Headphone Listening. HXD™ restores the directionality component of the spatial sound stage normally heard with Loudspeaker listening.

• **Alphanumeric Fluorescent Display**

The Front Panel Information Display indicates the Source Selection, Volume/Balance Levels and Setup Mode Selections. The display intensity is adjustable.

• **PASSTHRU Mode**

The Automatic PASSTHRU Mode allows the C47 to become part of a Home Theater Multichannel Sound System.

• **Remote Control with External Sensor Input**

The Remote Control provides control of the C47 operating functions and McIntosh Source Components connected to it. Enjoy your McIntosh System from another room in your home by connecting an external sensor.

• **Power Control Output and Trigger Assignment**

A Power Control connection for convenient Turn-On of McIntosh Power Amplifiers, Source Components and Accessories is included. The Power Control Trigger Outputs may be assigned to activate when a given Input/Output is selected.

• **Special Power Supply**

Fully regulated Power Supplies and a special R-Core Power Transformer ensure stable noise free operation even though the power line varies.

• **Glass Front Panel with LED Illumination**

The famous McIntosh Glass Front Panel is evenly lit by multiple extra long life Light Emitting Diodes (LEDs) arranged with a special orientation. The pristine beauty of the C47 will be retained for many years.

HXD® is a registered trademark of McIntosh Laboratory, Inc.

Dimensions

The following dimensions can assist in determining the best location for your C47. There is additional information on the next page pertaining to installing the C47 into cabinets.

Front View of the C47

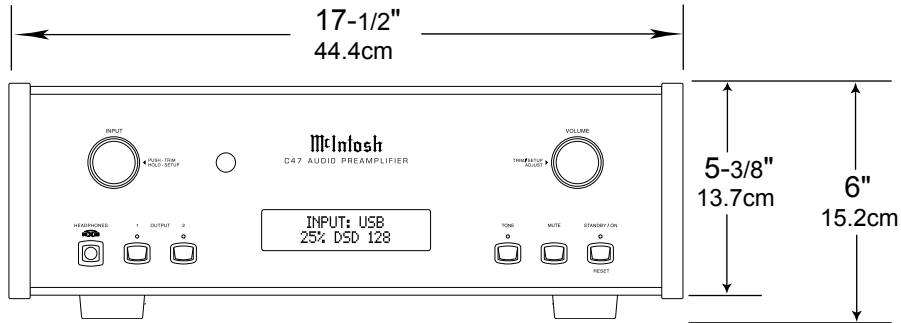

Rear View of the C47

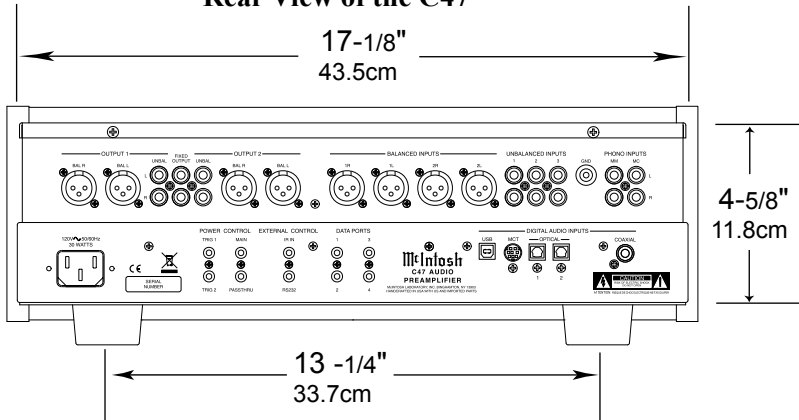

Side View of the C47

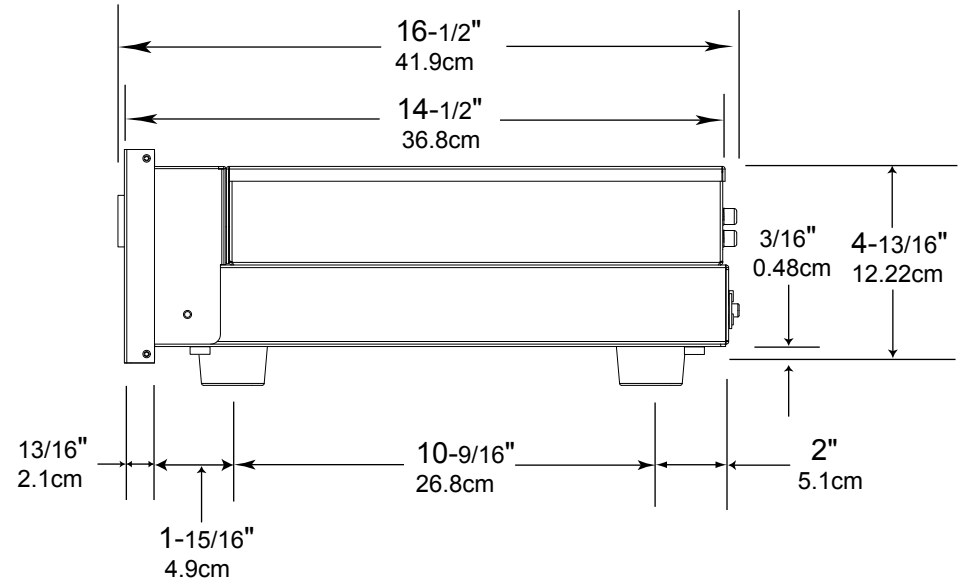

Installation

The C47 can be placed upright on a table or shelf, standing on its four feet. It also can be custom installed in a piece of furniture or cabinet of your choice. The four feet may be removed from the bottom of the C47 when it is custom installed as outlined below. The four feet together with the mounting screws should be retained for possible future use if the C47 is removed from the custom installation and used free standing. The required panel cutout, ventilation cutout and unit dimensions are shown.

Always provide adequate ventilation for your C47. Cool operation ensures the longest possible operating life for any electronic instrument. Do not install the C47 directly above a heat generating component such as a high powered amplifier. If all the components are installed in a single cabinet, a quiet running ventilation fan can be a definite asset in maintaining all the system components at the coolest possible operating temperature.

A custom cabinet installation should provide the following minimum spacing dimensions for cool operation.

Allow at least 2 inches (5.1cm) above the top, 2 inches (5.1cm) below the bottom and 1 inch (2.5cm) on each side of the Preamplifier, so that airflow is not obstructed. Allow 20 inches (50.8cm) depth behind the front panel. Allow 1-7/16 inch (3.7cm) in front of the mounting panel for knob clearance. Be sure to cut out a ventilation hole in the mounting shelf according to the dimensions in the drawing.

C47 Front Panel Custom Cabinet Cutout

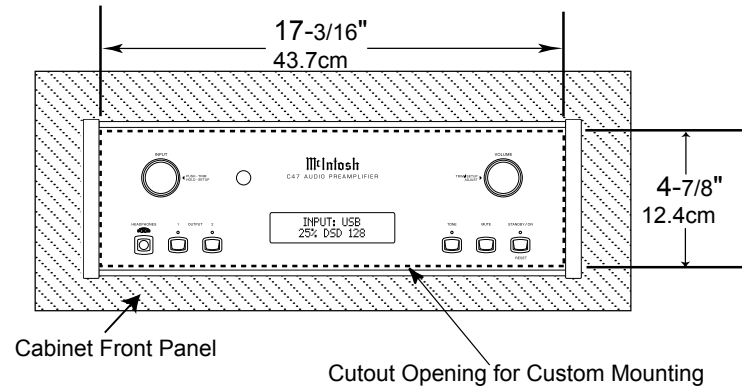

C47 Side View in Custom Cabinet

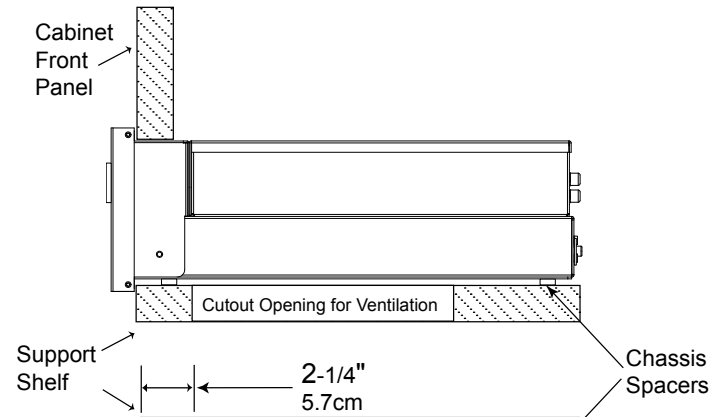

C47 Bottom View in Custom Cabinet

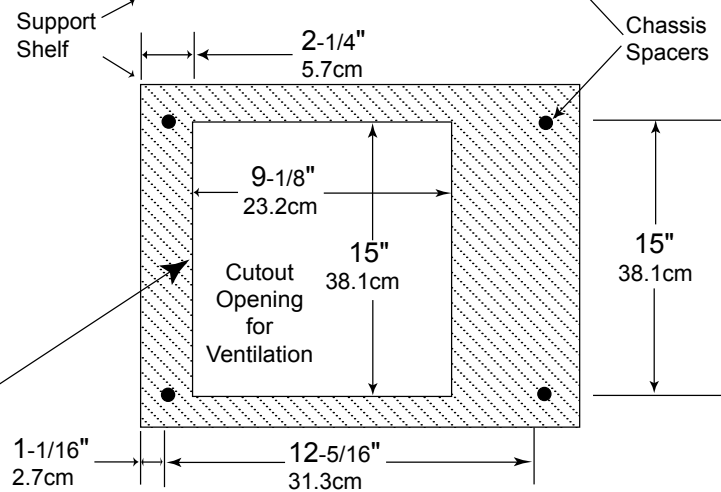

Note: Center the cutout Horizontally on the unit. For purposes of clarity, the above illustration is not drawn to scale.



Rear Panel Connections

The identification of Rear Panel Connections for the C47 Audio Preamplifier is located on a separate folded sheet contained in the Owner's Manual Packet. Refer to separate sheet "Mc2B" for the Rear Panel Connections.

C47 Audio Preamplifier Rear Panel

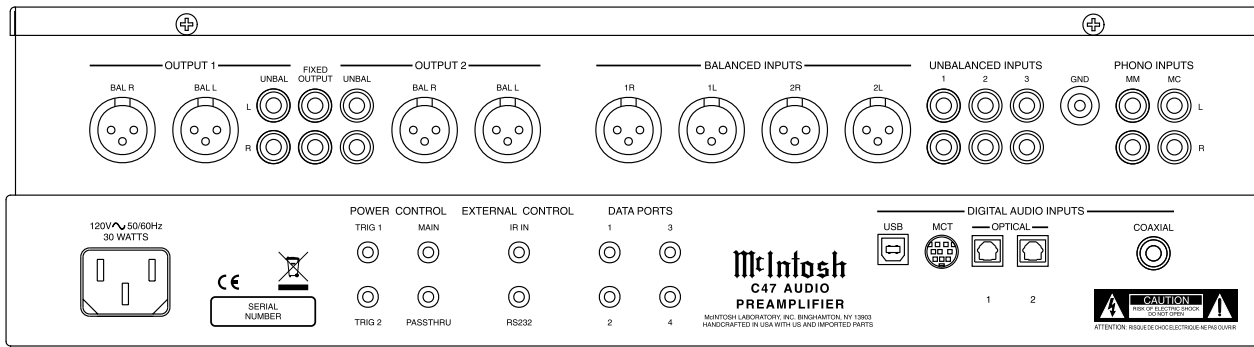

Connecting Components

The C47 has the ability to automatically switch power On/Off to Source Components via the Power Control connections. The Data Port Connections allow for the remote operation of basic functions using the C47 Remote Control HR085. With an external sensor connected to the C47, remote control operation of the system is possible from another room and/or when the C47 is located in a cabinet with the doors closed.

The connection instructions below, together with the C47 Input/Output/Control Connection Diagrams located on the separate folded sheets "Mc1A/1B and Mc2A", are an example of a typical audio system. Your system may vary from this, however the actual components would be connected in a similar manner. For additional information refer to "Connector and Cable Information" on page 4.

- Notes:*
1. The C47 allows renaming of the Audio Inputs Names as indicated on the Front Panel Information Display. Example, "UNBAL 1" may be changed to "TUNER" or your own personal preference. Refer to Setup "Renaming Input" on page 14.
 2. For convenience, an "Input Assignment Chart" on a separate sheet "Mc5A/5B" has been provided to keep track of changes.

Power Control Connections:

1. Connect a Control Cable from the C47 POWER CONTROL MAIN Jack to the Power Control In on the Turntable.
2. Connect a Control Cable from the Turntable Power Control Out Jack to the Digital Audio Player Trigger In Jack.
3. Connect a Control Cable from the Digital Audio Player Trigger Out Jack to the SACD Transport Power Control In Jack.
4. Connect a Control Cable from the SACD Trans-

port Power Control Out Jack to the Tuner Power Control In Jack.

5. Connect a Control Cable from the Tuner Power Control Out Jack to the Media Bridge Pwr Ctrl (Power Control) In Jack.
6. Connect a Control Cable from the C47 POWER CONTROL TRIG (Trigger) 1 Jack to the Power Amplifier Power Control In Jack.

Notes: 1. If two separate Power Amplifiers are used (Left and Right Channels), connect the Power Control Output of the first Amplifier to the Power Control Input on the second Amplifier.
2. By the default settings, POWER CONTROL Triggers 1 and 2 will be active when the C47 OUTPUT 1 and/or 2 is selected by the Front Panel or Remote Control Push-buttons.

7. Optionally, connect a Control Cable from the C47 POWER CONTROL TRIG (Trigger) 2 Jack to the Power Amplifier (Secondary Room) Power Control In Jack.
8. Connect any additional Components in a similar manner, as outlined in steps 1 thru 5.

Data Control Connections:

9. Connect a Control Cable from the C47 DATA PORTS 2 Jack to the TUNER Data In Jack.

Note: To have source components (e.g. Tuner) respond only to their specific "Function Commands" issued by the Remote Control, it is first necessary change the Data Ports Default settings for the "Tuner" Input. Refer to Setup "Data Port Assignment" on page 16.

10. Connect a Control Cable from the C47 CD DATA PORT 3 Jack to the SACD/CD Transport Data In Jack.
11. Connect a Control Cable from the C47 DATA PORT 1 Jack to the Media Bridge Data In Jack.

12. Connect any additional McIntosh Components in a similar manner, as outlined in steps 9 thru 11.

Sensor Connection:

13. Connect a Control Cable from the C47 IR Input Connector to the external Sensor. For additional information, refer to "General Information" note 8 on page 4.

Audio Connections:

14. Connect an Audio Cable from the C47 UNBALANCED INPUT 1 (Tuner) Jacks to the Tuner Unbalanced Output Jacks.
15. Using the "DIN Cable-Twisted Pair" cable (supplied with a MCT Transport) from the C47 MCT DIGITAL AUDIO INPUT connector to the SACD/CD Transport DIN Output connector.
16. Connect an XLR Audio Cable from the C47 BALANCED INPUT 1 connectors to the Media Bridge Balanced Output connectors.
17. Connect a Digital Coaxial Cable from the C47 DIGITAL AUDIO INPUT COAXIAL Jack to the Digital Audio Player Digital Coax Output Jack.
18. Connect the Audio Cables coming from the Turntable to the C47 MC PHONO INPUT Jacks.

Note: If the Turntable has a Moving Magnet Cartridge, connect the audio cables to the C47 MM PHONO INPUT instead of the MC Input.

19. Connect XLR Audio Cables from the C47 BALANCED OUTPUT 1 connectors (Left and Right) to the Power Amplifiers (Primary Room) Balanced (Left and Right) Inputs.
20. Optionally, connect XLR Audio Cables from the C47 BALANCED OUTPUT 2 connectors (Left and Right) to the Power Amplifier (Secondary Room) Balanced (Left and Right) Inputs.

21. Connect any additional McIntosh Components in a similar manner, as outlined in steps 14 thru 20.

Optional "PassThru" Connections:

22. Connect XLR Audio Cables from the A/V Processor, Front Channels (Left and Right) Balanced Output connectors to the C47 BALANCED INPUT 2 connectors.

Note: Refer to Setup "PASSTHRU" on page 17 to activate the BALANCED 2 Input.

23. Connect a Control Cable from the C47 PASSTHRU Jack to A/V Processor Power Control Zone ZA Jack.

Optional USB Connection:

24. Connect a USB cable with (type A to type B) connectors from the C47 USB DIGITAL AUDIO INPUT connector to an available USB connector on the computer.

Ground Connections:

25. Connect the Ground Cable coming from the Turntable to the C47 PHONO INPUT GND Binding Post.

AC Power Cord Connections:

26. Connect the C47 to a live AC Outlet using the supplied Power Supply Cord.

LEDs illuminate during the time a remote command is sent and when programming the remote control

Select the DEVICE to issue a remote control command to

SETUP Push-button is used as a "Shift Key" to select a function with blue color nomenclature

Selects AM Tuner Operating Functions, select Output 1 when used with the SETUP/shift Push-button and Track Selection on certain McIntosh CD Players

Press the Trim Push-button and then the LEVEL UP Push-button to select and adjust various functions. MENU is used with McIntosh Models displaying choices on a video screen

Activates the TRIM Mode. GUIDE is used with McIntosh Models displaying instructions on a video screen

Press the Trim Push-button and then the LEVEL DOWN Push-button to select and adjust various functions. INFO is used with McIntosh Models displaying information on a video screen

Scrolls through the available INPUTS

Mutes the audio

Selects transport functions of STOP, PLAY/PAUSE, RECORD, BACK for the previous-selection, FAST-REVERSE, FAST-FORWARD and NEXT for the next selection

Selects Previous Tuner Station PRESET

Tuner scans Down the dial to SEEK the next Station

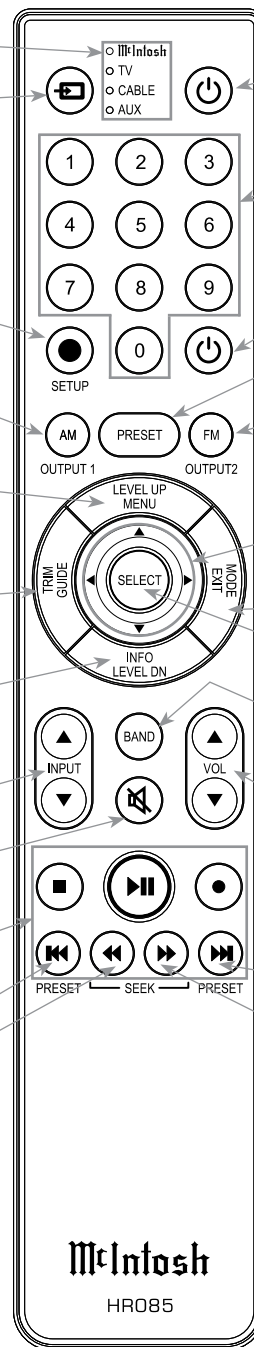

Press to Power the amplifier ON

Use to select tuner presets, direct access an AM/FM Station Frequency, disc tracks or any numbered operation

Press to Power the amplifier OFF

Direct access to stored Tuner PRESETS when used with the numeric Push-buttons (0 thru 9)

Selects FM Tuner Operating Functions, select Output 2 when used with the SETUP/shift Push-button and Track Selection on certain McIntosh CD Players

Use ▲ and ▼ to tune Up or Down the AM/FM Dial, use ► and ◀ for the next or previous HD Radio Program (were applicable)

Selects either Stereo or Mono MODE of operation. EXIT is used with McIntosh Models displaying information or choices on a video screen

Used to SELECT/Enter the indicated choice

Press to change broadcast bands on a connected Tuner. Select certain functions on a variety of McIntosh Models

Adjusts the VOLUME level up or down

Selects Next Tuner Station PRESET

Tuner scans Up the dial to SEEK the next Station

Note: Push-buttons whose function is not identified above are for use with other McIntosh Products.

How to use the Remote Control

The supplied C47 Remote Control (HR085) is capable of directly controlling the functions of contemporary McIntosh Source Components connected to the C47 via the Data Ports.

- Notes:*
- 1. If at any time the C47 seems unresponsive to the HR085 Remote Control Commands, press the  DEVICE Push-button to select McIntosh first.*
 - 2. For additional information on using the HR085 Remote Control with the McIntosh Model, please refer to the "How to Operate" starting on page 20.*
 - 3. For additional information on assigning the Data Ports, refer to "How to Setup" on page 16.*

Trim

Press the TRIM Push-button until the desired Trim function (Balance, Trim Level, etc.) appears on the C47 Front Panel Display, then press the LEVEL Up or Down Push-button to adjust the Trim setting.

Note: Press the TRIM Push-button to recall the last Trim function selected. For additional information on using the Trim Functions refer to "How to Operate" page 20.

Output Selection

Press the BLUE (Setup) Push-button followed by the AM (Output 1) or FM (Output 2) Push-button, to control the Rear Panel Audio OUTPUTS 1, 2 (ON or OFF) and Power Control TRIG 1 / TRIG 2.

Note: For additional information on assigning the Outputs (1 and 2) and Power Control Triggers (1 and 2) refer to page 16.



INPUT Control used to select a source for listening and recording. The control is also used to enter the TRIM or SETUP Modes and select the various functions

VOLUME Control allows adjustment of the listening level for both channels. Also used to change the various TRIM and SETUP Functions

IR Sensor receives commands from a Remote Control

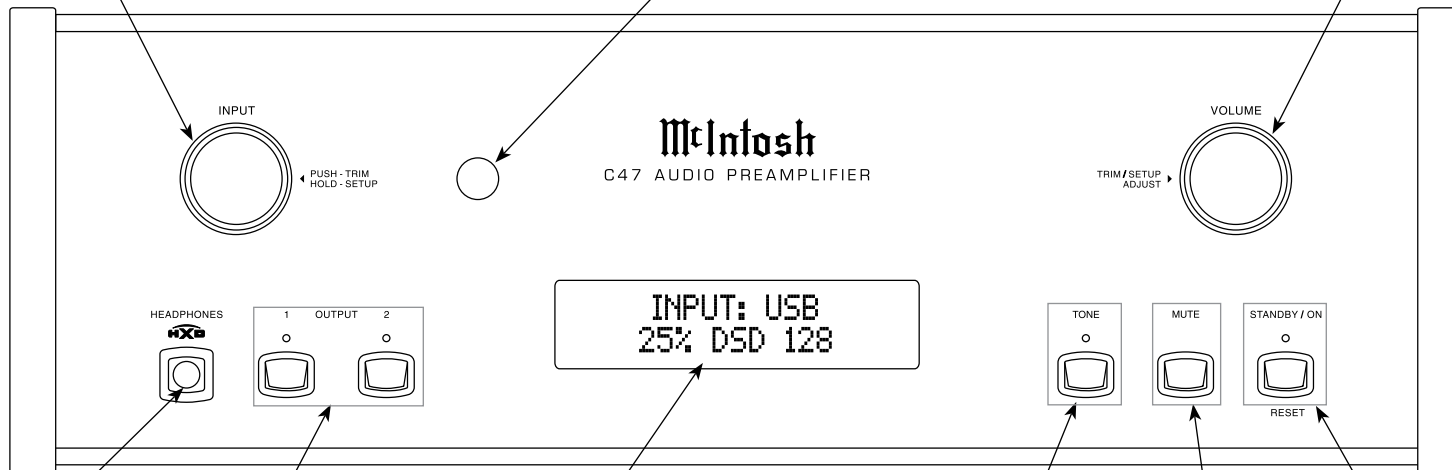

Connection for low impedance dynamic headphones, for private listening

OUTPUT 1 and 2 Push-buttons with indicators, switch the Preamplifier Outputs 1 and 2 On or Off

INFORMATION DISPLAY indicates the Sources, Volume, other Audio Settings, Operational Functions and Setup Mode Settings

TONE Push-button with indicator, when deactivated the audio signal bypasses the Trim Tone Controls

MUTE Push-button mutes the audio from the Loudspeakers and Headphones

STANDBY/ON Push-button with indicator, switches the C47 ON or OFF (Standby) and resets the microprocessors

How to Operate the Setup Mode

Your McIntosh C47 has been factory configured for default operating settings that will allow immediate enjoyment of superb audio without the need for further adjustments. If you wish to make changes to the factory default settings, a Setup Feature is provided to customize the operating settings using the Front Panel Information Display. Refer to the C47 Front Panel Illustration on the previous page while performing the following steps.

Note: If the C47 is currently On, proceed to step 2.

1. Press the STANDBY/ON Push-button on the Front Panel or press the  (Power ON) Push-button on the Remote Control to switch On the C47. The C47 will go through a brief startup initialization with the Front Panel Information Display indicating the last used source and volume setting. This is followed by the volume setting indication starting at zero and then increasing to the last used volume setting. Refer to figure 1.

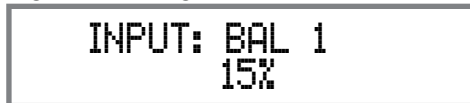

Figure 1

2. Press and hold in the INPUT Control until the Front Panel Information Display indicates “C47, V_ _ - S/N: AEH_ _ _” (or higher Firmware version). Refer to figure 2.

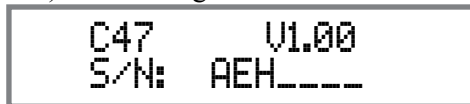

Figure 2

3. Rotate the INPUT Control to select the next Setup Mode Menu item, “SETUP: Inputs, (Hold INPUT)”. Refer to figure 3. Continue to rotate the INPUT CONTROL to view the other SETUP Mode Options.



Figure 3

4. To exit from the SETUP Mode, press and hold in the INPUT Control and the Front Panel Display will revert back to its normal display. Refer to figure 1.

Default Settings

The Default Settings Chart below indicates the Function Name, Default Setting and the Page Number for additional information.

Default Settings		
Function Name	Setting	Page No.
C47	V_ _ - _ _	13
INPUTS	On / Rename	13
OUTPUTS (1 & 2)	Switched	15
TRIGGER 1	Output 1	16
TRIGGER 2	Output 2	16
DATA PORTS (1 thru 4)	All Data	16
PASSTHRU	OFF	17
RS232 (Rate)	115200 Baud	17
Remote Control Codes	Normal	17
IR Sensor	Enabled	17
Power Mode	Enabled	17

Firmware Version

The C47 functionality is controlled by internal software that is known as Firmware. The Version of the Firmware in the C47 can be identified at any time by utilizing the Setup Mode.

1. Press and hold in the INPUT Control to enter Setup Mode.
2. Referring to the Front Panel Information Display—the number after the character “V” is the Firmware number. Refer to figure 2.
3. To exit the Setup Mode, press the INPUT Control.

Input Settings

The C47 provides the ability to switch unused INPUTS Off (or back On if they have been previously switched Off). The default INPUT Names can be changed to match the name of the component connected to it or any other custom name desired (within 10 Characters).

INPUT SWITCHED ON/OFF:

In the following example, the UNBAL 3 Input will be switched Off.

Note: When an INPUT is switched Off, its name will no longer appear on the Front Panel Information Display when using the INPUT Control (Front Panel or Remote Control).

1. Press and hold in the INPUT Control to enter the SETUP MODE. Refer to figure 2.
2. Rotate the INPUT Control until “SETUP: Inputs, (Hold INPUT)” appears on the Information Display. Refer to figure 3.
3. Press and hold in the INPUT Control until “SETUP: _____, On / Rename” appears on the Display. If necessary rotate the INPUT Control to select the UNBAL 3 Input. Refer to figure 4.

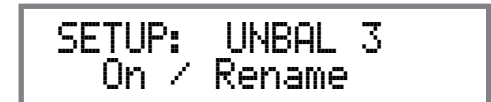

Figure 4

4. To switch the UNBAL 3 Input Off, rotate the VOLUME Control until the display indicates



Input Settings, con't

SETUP: UNBAL 3, Off". Refer to figure 5.



Figure 5

5. Exit the SETUP Mode by several presses of the INPUT Control.

In the following example, the UNBAL 3 Input will be switched On.

Notes: 1. When an INPUT is switched ON, its name will appear on the Front Panel Information Display when using the INPUT Control (Front Panel or Remote Control).

6. Press and hold in the INPUT Control to enter the SETUP MODE. Refer to figure 2, on page 13.
7. Rotate the INPUT Control until "SETUP: Inputs, (Hold INPUT)" appears on the Information Display. Refer to figure 3, on page 13.
8. Press and hold in the INPUT Control until "SETUP: _____, Off" appears on the Display. If necessary rotate the INPUT Control to select the UNBAL 3 Input. Refer to figure 5.
9. To switch the UNBAL 4 Input On, rotate the VOLUME Control until the display indicates SETUP: UNBAL 3, On / Rename". Refer to figure 4 on page 13.
10. Exit the SETUP Mode by several presses of the INPUT Control.

RENAME INPUT:

In the following example, the BALANCED 1 (BAL 1) Input will be renamed to match up with the component connected (refer to page 9, step 15).

The C47 Default Input Names (UNBAL 1, BAL 1, COAX 1, etc.) as indicated on the Front Panel Display can be customized to a different name up to ten characters long (TUNER, CD PLAYER, etc.). The

available characters for renaming the input include the following: ! < > * , / - _ 0 1 2 3 4 5 6 7 8 9 A B C D E F G H I J K L M N O P Q R S T U V W X Y Z .

In the following example, the BAL 1 Input will be renamed to "MEDIA BRDG".

11. Press and hold in the INPUT Control to enter the SETUP MODE. Refer to figure 2, on page 13.
12. Rotate the INPUT Control until "SETUP: Inputs, (Hold INPUT)" appears on the Information Display. Refer to figure 6.



Figure 6

13. Press and hold in the INPUT Control until "SETUP: BAL 1, On / Rename" appears on the Display. If necessary rotate the INPUT Control to select the BAL 1 Input. Refer to figure 7.



Figure 7

14. Press and hold in the INPUT Control until "RENAME: BAL 1, >BAL 1 <" appears on the Display. The character "B" is flashing to indicate it is ready to be changed. Refer to figure 8.



Figure 8

15. Rotate the VOLUME (ADJUST) Control to change the character "B" to "M". Refer to figure 9.



Figure 9

16. Rotate the INPUT Control until the character "A" is flashing, then rotate the VOLUME (ADJUST) Control to change the character "A" to "E". Refer to figure 10.



Figure 10

17. Rotate the INPUT Control until the character "L" is flashing, then rotate the VOLUME (ADJUST) Control to change the character "L" to "D". Refer to figure 11.



Figure 11

18. Rotate the INPUT Control until the "_" empty space to the right of character D is flashing, then rotate the VOLUME (ADJUST) Control to change the "_" empty space to character "I". Refer to figure 12.



Figure 12

19. Repeat steps 15 thru 18 until the new name of "RENAME: BAL 1, MEDIA BRDG" is indicated on the Front Panel Display. Refer to figures 13 thru 19.



Figure 13



Figure 14



Figure 15



Figure 16



Figure 17



Figure 18



Figure 19

20. To save the new name, press and hold in the INPUT Control until “SETUP: MEDIA BRDG , ON / Rename” appears on the Front Panel Information Display. Refer to figure 20.



Figure 20

21. Exit the SETUP Mode by several presses of the INPUT Control.

Note: For convenience, an “Input Assignment Chart” on a separate sheet “Mc5A/5B” has been provided to keep track of changes.

Output Settings

The Output Settings provide the ability to change how the C47 Output 1, Output 2 and Headphones function. OUTPUT 1 and 2:

By default OUTPUT 1 and 2 are set to go On/Off by using the Front Panel OUTPUT 1 and 2 push-buttons or by using the OUTPUT 1 and 2 push-buttons on the Remote Control. If it is desirable to have OUTPUT 1 and/or 2 always On regardless of the OUTPUT 1 and 2 Push-button settings perform the following:

1. Press and hold in the INPUT Control to enter the SETUP MODE. Refer to figure 2 on page 13.
2. Rotate the INPUT Control until “SETUP: Outputs, (Hold INPUT)” appears on the Information Display. Refer to figure 21.

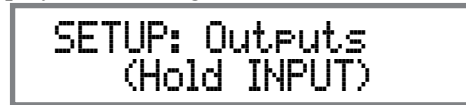

Figure 21

3. Press and hold in the INPUT Control until “SETUP: OUTPUT 1, Switched” appears on the Display. Refer to figure 22.



Figure 22

4. Rotate the VOLUME (ADJUST) Control to change from the “Switched” setting to “Unswitched”. Refer to figure 23.



Figure 23

5. In a similar manner, perform steps 3 and 4 to change the OUTPUT 2 setting. Refer to figures 24 and 25.



Figure 24



Figure 25

The C47 Default Setting for using Headphones is to automatically mute all the Output Connectors when the Headphone Cable Plug is inserted into the C47 Front Panel HEADPHONES Jack. There are three available settings:

- Mute All Outputs
- Mute Main Output
- Mute No Outputs

6. Rotate the INPUT Control until “SETUP: HEADPHONES, Mute All Outputs” appears on the Information Display. Refer to figure 26.



Figure 26

7. Rotate the VOLUME (ADJUST) Control to change the current HEADPHONES setting from “Mute All Outputs” to either “Mute Main Output” or “Mute No Outputs”. Refer to figures 27 and 28.



Figure 27



Figure 28

8. Exit the SETUP Mode by several presses of the INPUT Control.

Power Control Triggers 1 and 2

By default the Power Control TRIGGER 1 and TRIGGER 2 are assigned to activate when Output 1 or Output 2 is selected. Both Triggers can also be reassigned to a given Input or Inputs or go On/Off with the C47 power.

In the first example, the Power Control Triggers 1 and 2 will be assigned to MAIN:

1. Press and hold in the INPUT Control to enter the SETUP MODE. Refer to figure 2 on page 13.
2. Rotate the INPUT Control until “SETUP: Triggers, (Hold INPUT)” appears on the Information Display. Refer to figure 29.

Figure 29

3. Press and hold in the INPUT Control until “SETUP: TRIGGER 1, Output 1” appears on the Display. Refer to figure 30.

Figure 30

4. Rotate the VOLUME (ADJUST) Control to select Main from the available additional selections including Output 2 or Input. Refer to figure 31.

Figure 31

5. In a similar manner, perform steps 3 and 4 to change the Trigger 2 setting from OUTPUT 2 to Main. Refer to figure 32 and figure 31.

Figure 32

The second example will use selection of Trigger 2 to activate when the BAL 1 Input is selected:

6. Rotate the INPUT Control to select “SETUP: TRIGGER 3, Main” appears on the Display.
7. Rotate the VOLUME (ADJUST) Control to select “SETUP: TRIGGER 2, Input” appears on the Display. Refer to figure 33.

Figure 33

8. Press and hold in the INPUT Control until “SETUP: TRIGGER 2, Bal 1: OFF” appears on the Display. Refer to figure 34.

Figure 34

9. Rotate the VOLUME (ADJUST) Control to select “Bal 1: ON”. Refer to figure 35.

Figure 35

10. Exit the SETUP Mode by several presses of the INPUT Control.

Data Ports

Data Ports Connections between the C47 and a McIntosh Source Component allow for basic function control of the source component using the C47 supplied HR085 Remote Control. By default, all of the four Data Ports are set to send the same Data to the selected source. To dedicate a given Data Port for only one source component (example, source component connected to the BAL 1 Input will be assigned to Data Port 1) perform the following Steps:

1. Press and hold in the INPUT Control to enter the SETUP MODE. Refer to figure 2 on page 13.
2. Rotate the INPUT Control until “SETUP: Data Ports, (Hold INPUT)” appears on the Information Display. Refer to figure 36.

Figure 36

3. Press and hold in the INPUT Control until “SETUP: DATA PORT 1, All Data” appears on the Display. Refer to figure 37.

Figure 37

4. Rotate the VOLUME (ADJUST) Control to select “BAL 1” Input. Refer to figure 38.

Figure 38

5. In a similar manner, perform steps 3 and 4 to assign any additional Data ports.
6. Exit the SETUP Mode by several presses of the INPUT Control.

Passthru

When the C47 is part of a Home Theater or Multichannel Audio System the Right and Left Front Channels from an Audio/Video Processor or Surround Decoder can “Passthru” the C47 and onto its associated Power Amplifier(s). The Setup Mode allows selection of the specified C47 Input to be used for the Right and Left Front Channels. In the example below, the Right and Left Front Channels from the Audio/Video Processor will be connected to the BALanced 2 Input Connectors on the C47. Refer to pages 8 and 9 for additional connection information.

Note: The Phono and Digital Inputs are not assignable as a Passthru Input.

1. Press and hold in the INPUT Control to enter the SETUP MODE. Refer to figure 2 on page 13.
2. Rotate the INPUT Control until “SETUP: Passthru, Off” appears on the Information Display. Refer to figure 39.



SETUP: Passthru
Off

Figure 39

3. Rotate the VOLUME (ADJUST) Control to select “BAL 2” Input. Refer to figure 40.



SETUP: Passthru
BAL 2

Figure 40

4. Exit the SETUP Mode by several presses of the INPUT Control.

Comm Port Baud Rate

The C47 may be remotely controlled from other equipment connected to the Rear Panel RS232 Jack. The speed at which the C47 communicates (8 bit, no parity and 1 stop bit) with other equipment is adjustable from 9,600 bits per second to 115,200 bits per second. To change from the default speed of 115,200 bits per second, perform the following steps:

1. Press and hold in the INPUT Control to enter the SETUP MODE. Refer to figure 2 on page 13.
2. Rotate the INPUT Control until “SETUP: RS232, 115200 Baud” appears on the Information Display. Refer to figure 41.



SETUP: RS232
115200 Baud

Figure 41

3. Rotate the VOLUME (ADJUST) Control to select the desired Baud Rate Speed.
4. Exit the SETUP Mode by several presses of the INPUT Control.

Remote Control Codes

The Remote Control included with the C47 utilizes the NORMAL McIntosh Control Codes. The Second Set of Control Codes the C47 will respond to is referred to as the ALTERNATE Codes. The Alternate Codes are used when the C47 is used in the same location as another McIntosh Preamplifier and/or A/V Processor. This will prevent the Remote Control from affecting the operation of both units at the same time. To activate the Remote Control ALTERNATE Codes perform the following steps:

1. Press and hold in the INPUT Control to enter the SETUP MODE. Refer to figure 2 on page 13.
2. Rotate the INPUT Control until “SETUP: IR Codes, Normal” appears on the Information Display. Refer to figure 42.



SETUP: IR Codes
Normal

Figure 42

3. Rotate the VOLUME (ADJUST) Control to the Alternate Codes. Refer to figure 43.



SETUP: IR Codes
Alternate

Figure 43

4. It is now necessary to change the HR085 Remote Control over to the Alternate Codes. Information on the HR085 Remote Control is available for download from the McIntosh Web Site:

<http://www.mcintoshlabs.com/us/Products/pages/ProductDetails.aspx?CatId=preamplifiers&ProductId=C47>

5. Exit the SETUP Mode by several presses of the INPUT Control.

IR Sensor

The C47 Front Panel Sensor, which receives the signals from the HR085 Remote Control, can be switched off to prevent interference when an external IR Sensor is connected. To de-activate the Front Panel IR Sensor perform the following steps:

1. Press and hold in the INPUT Control to enter the SETUP MODE. Refer to figure 2 on page 13.
2. Rotate the INPUT Control until “SETUP: Front IR, Enabled” appears on the Information Display. Refer to figure 44.

Figure 44

3. Rotate the VOLUME (ADJUST) Control to select Disabled. Refer to figure 45.

Figure 45

5. Exit the SETUP Mode by several presses of the INPUT Control.

Power Mode

The C47 incorporates an Auto Off Feature, which automatically places the preamplifier into the Power Saving Standby/Off Mode. This occurs approximately 30 minutes after there has been an absence of user activity (includes changes to any of the Operation Functions such as source selection, volume adjustment, etc) or absence of an audio signal. If it is desirable to disable the Auto Off Feature perform the following steps:

1. Press and hold in the INPUT Control to enter the SETUP MODE. Refer to figure 2 on page 13.
2. Rotate the INPUT Control until “SETUP: Auto Off, Enabled” appears on the Information Display. Refer to figure 46.

Figure 46

3. Rotate the VOLUME (ADJUST) Control to select Disabled. Refer to figure 47.

Figure 47

4. Press the EQ BYPASS/SETUP Push-button to exit the Setup Mode.

Factory Reset

If it becomes desirable to reset all the adjustable settings (Setup and Trim Settings) to the factory default values, perform the following steps:

1. Press and hold in the INPUT Control to enter the SETUP MODE. Refer to figure 2 on page 13.
2. Rotate the INPUT Control until “FACTORY RESET, (Hold INPUT)” appears on the Information Display. Refer to figure 48.

Figure 48

3. Press and hold in the INPUT Control until “FACTORY RESET, In Progress!” appears on the Information Display, then release the INPUT Control. Refer to figures 49 and 50.

Figure 49

Figure 50

4. Press the Front Panel STAND/BY Push-button to switch the C47 on.





How to Operate the C47

Power On and Off

The Red LED above the STANDBY/ON Push-button lights to indicate the C47 is in Standby mode. To switch ON the C47, press the STANDBY/ON Push-button on the Front Panel or the  (Power On) Push-button on the Remote Control. The C47 will go through a brief startup initialization with the Front Panel Information Display indicating the last used source and volume setting, this is followed by the volume setting indication starting at zero and then increasing to the last used volume setting. Refer to figures 60, 61, 62 and 63. To switch OFF the C47 press the STANDBY/ON Push-button on the Front Panel or the OFF Push-button on the Remote Control.

Note: For an explanation of the Remote Control Push-button functions, refer to pages 10 and 11.



Figure 61

Source Selection

Rotate the INPUT Control to select the desired source or press the INPUT Up▲ or Down▼ Push-button on the Remote Control. Refer to figures 60, 62 and 63.

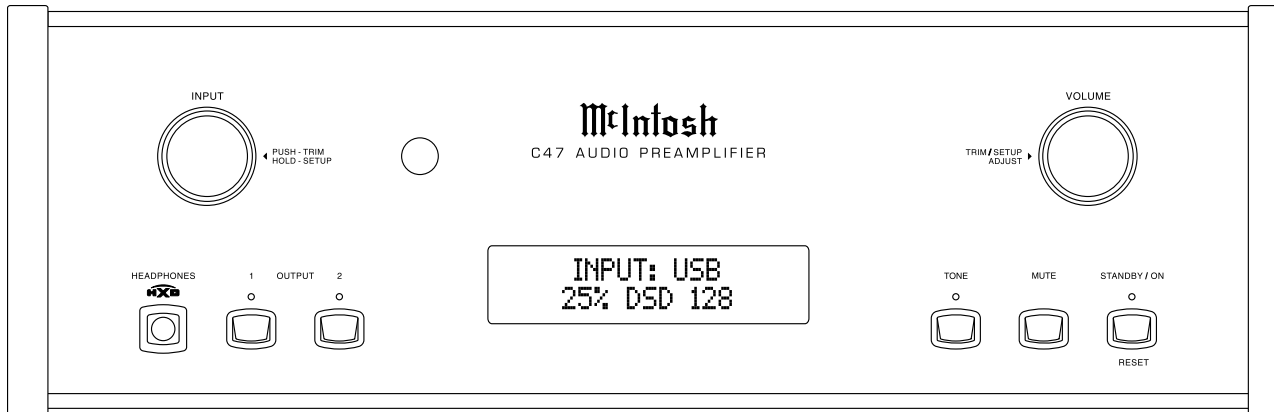

Figure 60

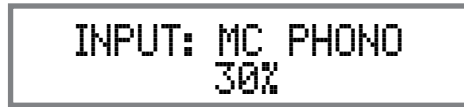

Figure 62

Volume Control

Rotate the Front Panel VOLUME Control or use the VOLUME Up▲ or Down▼ Push-buttons on the Remote Control for the desired listening level. Refer to figures 60 and 63.

Trim Functions

The C47 has nine different Trim Selections with Adjustments. The Trim Selections include Balance, Input Trim Level, Treble, Bass, Mono/Stereo Mode, Amplifier Meter Lights, Display Brightness, Phono Cartridge (MC & MM) Loading (when the Input is Selected) and when Headphones are connected HXD Mode. The Trim Settings are stored in memory independently for each Input Source Selected, except the Meter Illumination and Display Brightness settings of On or Off, which are the same for all inputs.

Note: Selection and Adjustment of all Trim Functions may be performed by pressing the Front Panel

INPUT Trim Control and then rotating it to select the desired Trim Function. Then use the VOLUME Adjust Control to change the setting. Remote Control TRIM Push-Button together with the LEVEL UP / Down Push-button may also be used. Refer to figures 60 and 63.

BALANCE

Listening balance varies with different program sources, room acoustics and listening positions relative to the Loudspeakers. Use the Balance (Trim Function) as needed to achieve approximately equal listening volume levels in each Loudspeaker. To adjust the Balance perform the following:

1. Press the TRIM Push-button repeatedly on the Remote Control until “L BALANCE R” appears on the Front Panel Information Display. Refer to figure 64.
- Note: The Front Panel INPUT Trim and VOLUME Adjust Controls may also be used.*
2. Press the LEVEL UP / DOWN Push-buttons on the Remote Control to emphasize the Right Channel (refer to figure 65) or



Figure 64

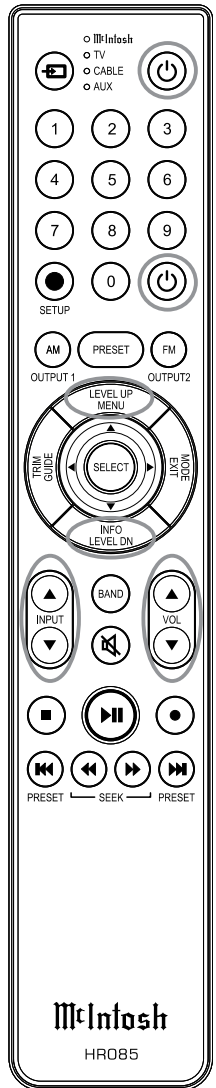

Figure 63

the Left Channel (refer to figure 66).



Figure 65



Figure 66

The Front Panel Display indicates the Balance changes are from 0 to 50dB. After approximately 4 seconds the Information Display returns to indicate the Source Selection and Volume Level. To verify the Balance setting without changing it, use the TRIM Push-button and select Balance.

TRIM LEVEL

Source Components can have slightly different volume levels resulting in the need to readjust the C47 Volume Control when switching between different sources. The C47 allows the adjustment of levels for each of the Source Inputs for the same relative volume. To adjust the Trim Level for the currently selected Input Source perform the following steps:

1. Select "INPUT TRIM" as indicated on the Front Panel Information Display. Refer to figures 60, 63 and 67.

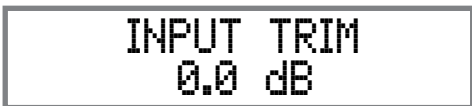

Figure 67

2. Adjust the Trim Level of each Input to match the average volume level of the Input most frequently listened to. The range of adjustment is ± 6.0 dB in half dB steps. Refer to figures 68 and 69.



Figure 68



Figure 69

After approximately 6 seconds the Information Display returns to indicate the Source Selection and Volume Level.

TREBLE

The Intensity of the High Frequencies in the music can be increased or decreased by using the Trim Select and Trim Adjust Control. To make an adjustment perform the following:

1. Use the Front Panel INPUT/TRIM Control or the TRIM Push-button on the Remote Control until "TREBLE, 0 dB" appears on the Front Panel Information Display. Refer to figure 70.



Figure 70

2. Rotate the VOLUME/ADJUST Control or press the LEVEL UP / DOWN Push-buttons to increase (refer to figure 71) or decrease (refer to figure 72) the volume level of the high frequencies.

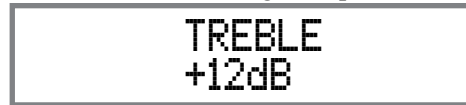

Figure 71



Figure 72

The Front Panel Display indicates the Treble changes in steps from +12dB to -12dB. After approximately 6 seconds the Display returns to indicate the Source Selection and Volume Level.

BASS

The Intensity of the Low Frequencies in the music can be increased or decreased by using the Trim Select and Trim Adjust Controls. To make an adjustment perform the following:

1. Use the Front Panel INPUT/TRIM Control or press the TRIM Push-button on the Remote Control until "BASS 0 dB" appears on the Front Panel Information Display. Refer to figure 73.



Figure 73

2. Rotate the INPUT/TRIM Control or press the LEVEL + / - Push-buttons to increase (refer to figure 74) or decrease (refer to figure 75) the volume level of the low frequencies.



Figure 74



Figure 75

The Front Panel Display indicates the Bass changes in steps from +12dB to -12dB. After approximately 6 seconds the Display returns to indicate the Source Selection and Volume Level.



How to Operate the C47, con't

TONE CONTROL

With the Tone Controls Enabled (default setting), the TRIM TREBLE and BASS Settings may be adjusted for the currently selected Input Source. The LED above the TONE Push-button will be illuminated. When the Tone Controls are Disabled the previous settings for Treble and Bass are bypassed from the signal path. To deactivate Tone Controls perform the following:

1. Select the desired Input Source.
2. Press the TRIM Push-button on the Remote Control until “TONE CONTROLS, Enabled” appears on the Front Panel Display. Refer to figure 76.



Figure 76

3. Press TRIM LEVEL UP / DOWN Push-button to activate the Tone Bypass. Refer to figure 77.



Figure 77

After approximately 6 seconds the Display returns to indicate the Source Selection and Volume Level.

MONO/STEREO MODE

By default the Stereo Mode is active for all Input Sources however, any Input Source may be assigned to Mono Mode. To change Stereo Mode to Mono for a given Input Source, perform the following steps:

Note: The audio signal present at the FIXED OUT Jacks is affected by the Stereo/Mono setting.

1. Select the desired Input Source.
2. Select “MONO / STEREO, _____” as indicated on the Front Panel Information Display. Refer to figure 78.



Figure 78

3. To select MONO Mode adjust the TRIM LEVEL. Refer to figure 79.



Figure 79

After approximately 6 seconds the Information Display returns to indicate the Source Selection and Volume Level.

AMPLIFIER METER ILLUMINATION

The Meter Illumination of recent McIntosh Power Amplifiers may be switched On or Off by performing the following:

1. Select “AMP METER LIGHTS, On” as indicated on the Front Panel Information Display. Refer to figures 60, 63 (on page 20) and 80.



Figure 80

2. Switch Off the Meter Illumination. Refer to figure 81.



Figure 81

After approximately 6 seconds the Information Display returns to indicate the Source Selection and Volume Level.

Notes: 1. Control of Meter Illumination via the C47 for recent McIntosh Power Amplifiers requires a power control cable connection between the Power Amplifier and C47.

2. Some A/V Processors will provide an On/Off Control Signal when the C47 Passthru Input Jack is connected to the A/V Processor via the power control cable.

INFORMATION DISPLAY ILLUMINATION

The Brightness Level of C47 Front Panel Information Display can be adjusted from bright to dim by performing the following:

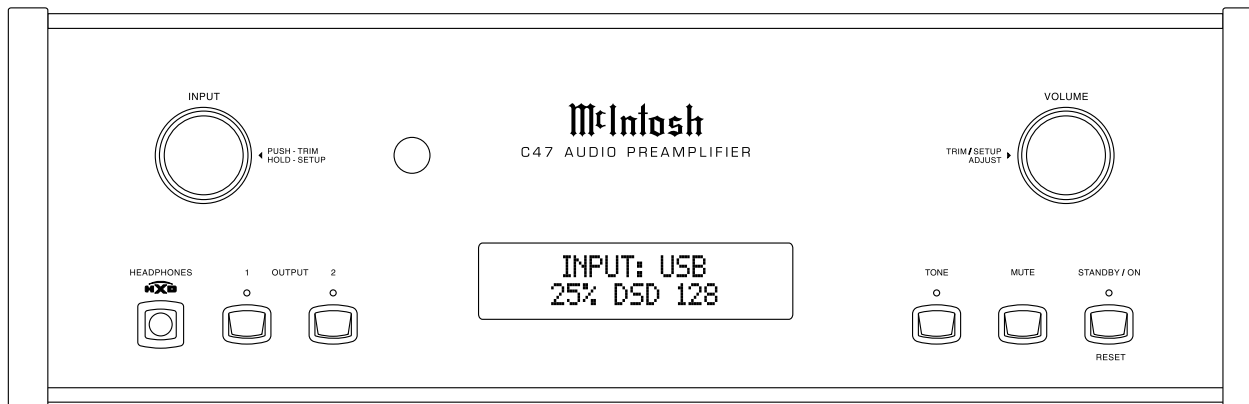

Figure 60

1. Select “DISPLAY BRIGHTNESS” as indicated on the Front Panel Information Display. Refer to figures 60, 63 (on page 20) and 82.



Figure 82

2. Reduce the Brightness level by adjusting the TRIM LEVEL. Refer to figure 83.



Figure 83

After approximately 6 seconds the Information Display returns to indicate the Source Selection and Volume Level.

PHONO ADJUSTMENTS

When the Phono MC or Phono MM Input is selected an additional TRIM SELECT FUNCTION becomes available for adjustment. Perform the following steps to make the Phono Trim Adjustments:

1. Select either the Phono MM or Phono MC Source Input.
2. Select “MC PHONO LOAD, 400Ω (ohms)” or “MM PHONO LOAD, 50pF” as indicated on the Front Panel Information Display. Refer to figures 84 and 85.



Figure 84



Figure 85

3. Set the desired phono cartridge loading value (Ohms for a Moving Coil Cartridge or Capacitance for a Moving Magnet Cartridge) that comes closest to the Phono Cartridge Makers recommended value.

After approximately 6 seconds the Alphanumeric Display returns to indicate the Source Selection and Volume Level.

Mute

Press the MUTE Push-button, on the C47 Front Panel or on the Remote Control, to Mute the Audio in all outputs (Main, Output 1, Output 2 and Headphones) except the FIXED OUTPUT. The Front Panel Information Display will indicate the Source Name and the word MUTE in place of the actual volume setting. Refer to figure 86.



Figure 86

Pressing the Mute Push-button a second time or adjusting the volume control (either the Front Panel or Remote Control) will unmute the C47.

Tone

Press the Front Panel TONE Push-button to activate the C47 TREBLE and BASS Tone Control Circuitry for the currently selected Input Source. The LED above the TONE Push-button will illuminate. To bypass the TONE CONTROL CIRCUITRY for the currently selected Input Source press the TONE Push-button. The LED above the EQUALIZER Push-button will extinguish.

Refer to figure 60. The C47 remembers for each selected Input whether the Tone Control Circuitry is active or bypassed.

Note. The audio signal present at the FIXED OUT Jacks is unaffected by the Equalizer Circuitry.

Output 1 and 2

Press the Front Panel OUTPUT 1 or OUTPUT 2 Push-button or use the Remote Control and press the SETUP/BLUE Push-button followed by the OUTPUT 1 or OUTPUT 2 Push-button, to send audio to separate Power Amplifiers connected to the rear panel OUTPUT 1 or 2 Jacks. It also activates the POWER CONTROL TRIGGER 1 or 2 Jacks on the rear panel of the C47. To stop the Audio and Power Control Signals from going to the separate Power Amplifiers, press the same Push-button(s) a second time.

Trim

Momentarily press the Front Panel INPUT Control to activate the C47 Trim Functions. Rotate the INPUT Control to select the desired Trim Function and then use the VOLUME (adjust) Control to change the Trim setting. Refer to figure 60. The Remote Control TRIM and LEVEL UP / DOWN Push-buttons may also be used. Approximately 6 seconds after Trim Function Selection and/or adjustments have stopped, the C47 will switch the Trim Mode Off.

Passthru

The C47 will automatically turn On and switch to the previously setup Passthru Input when the McIntosh A/V Processor or Multichannel Surround Decoder is turned-on. The Audio Preamp Front Panel Alphanumeric Display will indicate “PASSTHRU”. Refer to figure 87 on the next page.

How to Operate the C47, con't

Figure 87

The C47 OUTPUT 1 and 2 along with the TONE Front Panel Push-buttons are active when in the Passthru Mode. The other Front Panel Controls and Push-buttons are deactivated as long as the Passthru Mode is active.

Headphones Jack

Connect a pair of dynamic headphones to the Headphones Jack with a 1/4" (0.635cm) stereo phone type plug for private listening. The default setting is for all of the Power Amplifier Output Connections (Main, 1, 2, and 3) to automatically mute.

When headphones are connected to the C47 Front Panel Jack, an additional TRIM function becomes available. McIntosh's HXD brings the acoustical depth and spatiality of music normally heard with loudspeakers, to your headphones. Momentarily press the INPUT Control, then rotate it to select "HEADPHONE HXD, Off". To activate the HXD Mode rotate the VOLUME Adjust Control until the Front Panel Display indicates "HEADPHONE HXD, On". Refer to figures 83 and 84

Figure 88

Figure 89

Note: The Headphone Output is optimized for impedances ranging from 100 to 600 ohms.

How To Make a Recording

1. Select the desired signal source you wish to record by using the Front Panel INPUT Control or using the INPUT UP / DOWN Push-button on the Remote Control.
2. Adjust the record level using the recorder level control and proceed with the recording process.
3. Listen to the playback of the program source just recorded by selecting the Input Source connected to the recorder component output.

Optical and Digital Inputs

When a Digital Input (Optical or Coaxial Connection) on the C47 is selected, the Front Panel Information Display indicates the sampling frequency when a signal is present. Refer to figure 90. During the time there is no Digital Signal present the display will indicate "SILENT". Refer to figure 91.

Figure 90

Figure 91

USB Input Operation and Driver Installation

The C47 USB Input provides the capability to playback music from a computer, when the computer is connected to the rear panel USB connector.

Note: The USB Input is for direct connection to a computer only. To playback music from an USB Drive, connect the USB Drive to another USB Port on the computer and select the USB Drive with the Media Playback Program.

The C47 USB Input is compatible with PC Computers using Microsoft®, Windows 7 (SP1), Windows 8.1 and Windows 10. It is also compatible with Apple® Macintosh® Computers using OS-10.6.8 or later.

When using a PC Computer with Windows, a special McIntosh USB Audio Software Driver needs to be installed on the PC Computer. The driver needs to be installed before connecting the C47 USB Input to the USB Port on the computer.

Note: If an Apple Macintosh computer is used with the C47, no additional driver is required.

The McIntosh USB Audio Windows Driver is available for download from the McIntosh Web Site: <http://www.mcintoshlabs.com/us/Support/Pages/Manuals.aspx>

Under "PRODUCT CATEGORY" select "Pre-amplifiers" then under "MODEL NUMBER" select "C47". Click on "SEARCH" then select "McIntosh-HD USB Audio Windows Drive D v1.0 and download the PC Windows Driver. Follow the instructions below to install the McIntosh C47 Driver:

Purpose: To Install the McIntosh USB Audio Windows Driver for use with McIntosh Products with an USB-Digital Audio Input.

- Requirements:**
1. A PC Computer with a functioning USB Port.
 2. Windows 7 (SP1 or greater), Windows 8 (8.1) or Windows 10 Operating System.
 3. An USB Cable with Type A to Type B Connectors.

Installing the Software

It is important to first install the downloaded software on your computer before connecting the McIntosh Product to the computer. The USB Driver is included in the downloaded software package.

Note: Before installing this software, please check to see if the McIntosh Product(s) with the USB-Digital Audio Input has the latest firmware version, if not update the firmware first.

1. Unzip the downloaded McIntosh Windows USB Driver Software Package.
2. Run "McIntoshHDSwPkg_20150814_vlp9p110p2.zip". Refer to figures 92 thru 99.
3. When the Windows Security window appears check the *Always trust software from "Savitech Corp."* box and then the Install button. When the software has been installed, it is necessary to reboot the computer. Refer to figure 97.

After rebooting, a McIntosh-HD icon will appear on the desktop. Refer to figure 100.



Figure 100

USB Connection

Connect the USB Cable with Type A to Type B connectors between the PC Computer and the McIntosh Product with the USB-Digital Audio Input. An Icon will appear On-Screen indicating Windows has found new hardware. Refer to figure 101. Upon completion of installing the driver, figure 102 will appear.



Figure 101



Figure 102



Figure 92



Figure 93

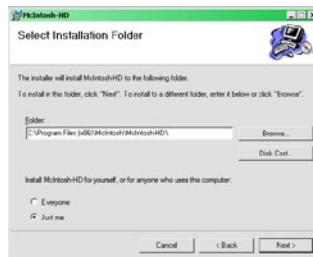

Figure 94

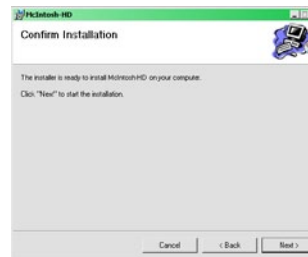

Figure 95

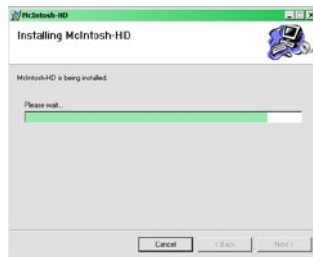

Figure 96

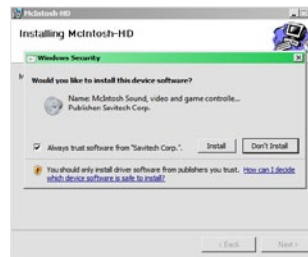

Figure 97



Figure 98

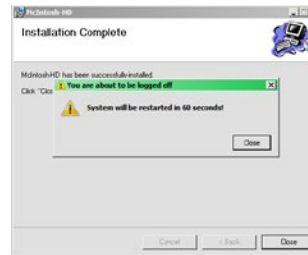

Figure 99

Windows Sound Settings

For proper operation of the McIntosh Product via the Computer USB Connection, it is required to make changes to Windows Sound Settings:

1. From the Windows START button, click on "CONTROL PANEL" followed by selecting "SOUND". Refer to figure 103.
2. Referring to figure 104, first select "McIntosh-HD HS USB Audio" and then click on the "Set Default" button.



Figure 103

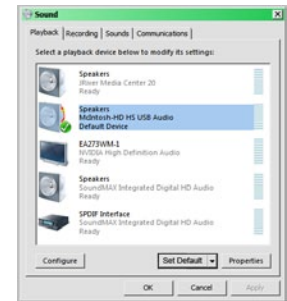

Figure 104

Notes: 1. When the McIntosh USB Audio Product is not connected to your computer, the previous default Audio Device will be selected.

2. *If other McIntosh Products with USB Audio Connections are also connected to the computer, an additional "McIntosh USB Audio" playback device will appear in the listing. Make sure to select the "McIntosh-HD HS USB Audio" from available playback devices listed when using this McIntosh Product for USB Audio.*

Control Panel Settings

To activate the McIntosh-HD USB Audio Control Panel Click on the “McIntosh Icon” (located in the Windows notification area on the right side of the taskbar) or click on the Windows “Show hidden icons”, then select the “McIntosh Icon”. Refer to figures 105 and 106.

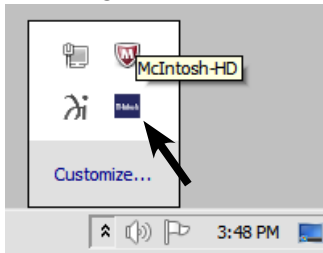

Figure 105

Notes: 1. It is not necessary for the McIntosh-HD USB Audio Control Panel to be running, unless it is desired to make changes to the default settings.

2. The McIntosh-HD USB Audio Control Panel displays the current Sampling Rate, Bit-Rate and Buffer Size for the music streaming from the computer into the C47.
3. When the Media Stream Program on the computer is set to output in the “ASIO” format, the McIntosh -HD USB Audio Control Panel allows for changing the settings parameters on the fly.

USB Music Playback

When the USB Input is selected on the McIntosh C47, the Front Panel Display indicates the Sampling Rate (refer to figures 107 and 108 for PCM Signals).



Figure 107



Figure 108

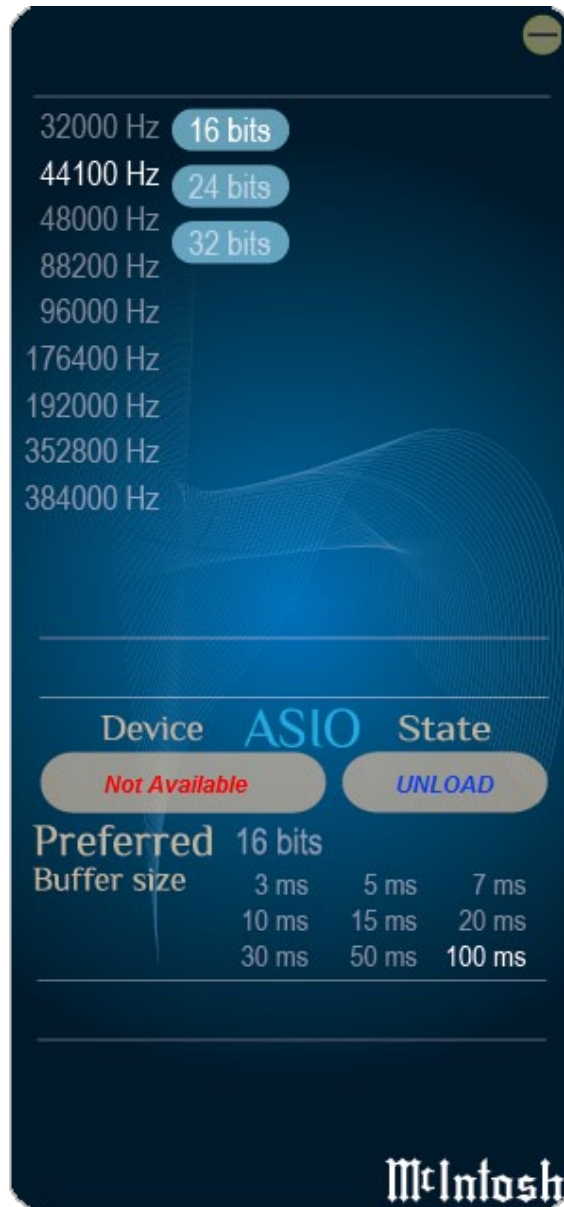

Figure 106

Figures 109 and 110 indicate a Sampling Rate of 128 or 256 times the Sampling Rate of a CD Disc for the incoming DSD Digital Audio Signal.



Figure 109



Figure 110

The Sampling Rate and the Bit Rate are determined by the original recording, the Application Output Format (when available) and the McIntosh-HD Control Panel Settings.

Note: In general, when the original music is recorded at a higher Sampling Rate, the result is usually more detail in the music. However, this higher rate results in consuming larger amounts of storage space. The Sample Rate usually should be set to match the Sample Rate of the music recording being played back.

There are many third party Applications (besides Applications like Windows Media Player) for steaming music from the computer to McIntosh C47 USB Input. An example of just one of the available applications is “JRiver Media Center”.

Reset of Microprocessors

In the unlikely event the controls of the C47 stop functioning, the microprocessors can be reset by performing the following:

1. Press and hold in the STANDBY/ON Push-button until the LED above the STANDBY/ON Push-button illumination is extinguished. Then release the STANDBY/ON Push-button.

2. To switch the C47 back On, press the STANDBY/
ON Push-button.

*Note: This can be performed with the C47 On or in the
Standby Mode.*









Specifications

Frequency Response

+0, -0.5dB from 20Hz to 20,000Hz
+0, -3dB from 15Hz to 100,000Hz

Total Harmonic Distortion

0.005% from 20Hz to 20,000Hz

Rated Output

2.5V Unbalanced, 5V Balanced (Main)
450mV (Fixed Output)

Maximum Voltage Output

8V RMS Unbalanced, 16V RMS Balanced

Sensitivity (for rated output)

High Level, 450mV Unbalanced, 900mV Balanced
Phono MM, 4.5mV
Phono MC, 0.45mV

Signal To Noise Ratio (A-Weighted)

High Level - 100dB (Below rated output)
MM Phono - 82dB (Below 5mV input)
MC Phono - 80dB (Below 0.5mV input)

Input Impedance

High Level - 22K ohms Unbalanced
44k ohms Balanced

Phono MM - 50 to 800pF, in 50pF steps;
47K ohms

Phono MC - 25, 50, 100, 200, 400 or 1,000 ohms;
100pF

Maximum Input Signal

High Level, 5V Unbalanced, 10V Balanced
Phono MM, 50mV
Phono MC, 5mV

Voltage Gain

High Level to Fixed Output: 0dB
High Level to Main Output: 15dB
Phono MM to Record Output: 40dB
Phono MC to Record Output: 60dB

Output Impedance

100 ohms Unbalanced
200 ohms Balanced

Headphone Load Impedance

100 ohms to 600 ohms

Digital Input Sample Rates

Optical: PCM - 16Bit, 24Bit - 32kHz to 192kHz
Coaxial: PCM -16Bit, 24Bit - 32kHz to 192kHz
MCT: PCM, SACD, -16Bit, 24Bit - 32kHz to 192kHz

USB: PCM - 16Bit, 24Bit, 32Bit - 32kHz to 384kHz
DXD - DXD352.8kHz, DXD384kHz
DSD - DSD64, DSD128, DSD256

Power Control and Trigger Output

12VDC, 25mA

Power Requirements

Field AC Voltage conversion of the C47 is not possible. The C47 is factory configured for one of the following AC Voltages:

- 100 Volts, 50/60Hz at 30 watts
- 110 Volts, 50/60Hz at 30 watts
- 120 Volts, 50/60Hz at 30 watts
- 220 Volts, 50/60Hz at 30 watts
- 230 Volts, 50/60Hz at 30 watts
- 240 Volts, 50/60Hz at 30 watts

Standby Power, less than 0.5 watts

Note: Refer to the rear panel of the C47 for the correct voltage.

Overall Dimensions

Width is 17-1/2 inches (44.4cm)
Height is 6 inches (15.2cm) including feet
Depth is 18 inches (45.72cm) including the Front Panel, Knobs and Cables

Weight

23 pounds (10.4 kg) net, 37.5 pounds (17 kg) in shipping carton

Shipping Carton Dimensions

Width is 27 inches (68.6cm)
Height is 12 inches (30.5cm)
Depth is 25 inches (63.5cm)

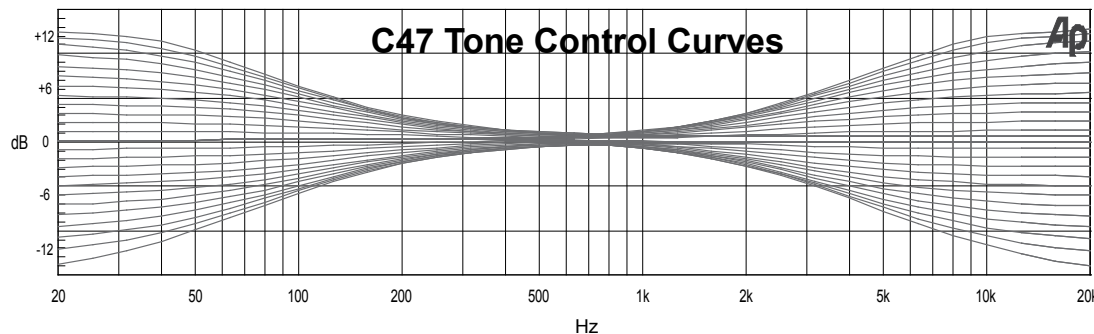

Packing Instructions

In the event it is necessary to repack the equipment for shipment, the equipment must be packed exactly as shown below. It is very important that the four plastic feet are attached to the bottom of the equipment.

This will ensure the proper equipment location on the bottom pad. Failure to do this will result in shipping damage.

Use the original shipping carton and interior parts only if they are all in good serviceable condition. If a shipping carton or any of the interior part(s) are needed, please call or write Customer Service Department of McIntosh Laboratory. Refer to page 3. Please see the Part List for the correct part numbers.

Quantity	Part Number	Description
1	033838	Shipping carton only
4	033837	End cap
1	033836	Inside carton only
1	033725	Inner carton top pad
1	034301	Bottom pad
2	034446	Foam plug
4	017937	Plastic foot
4	400159	#10-32 x 3/4" screw
4	404080	#10 Flat washer

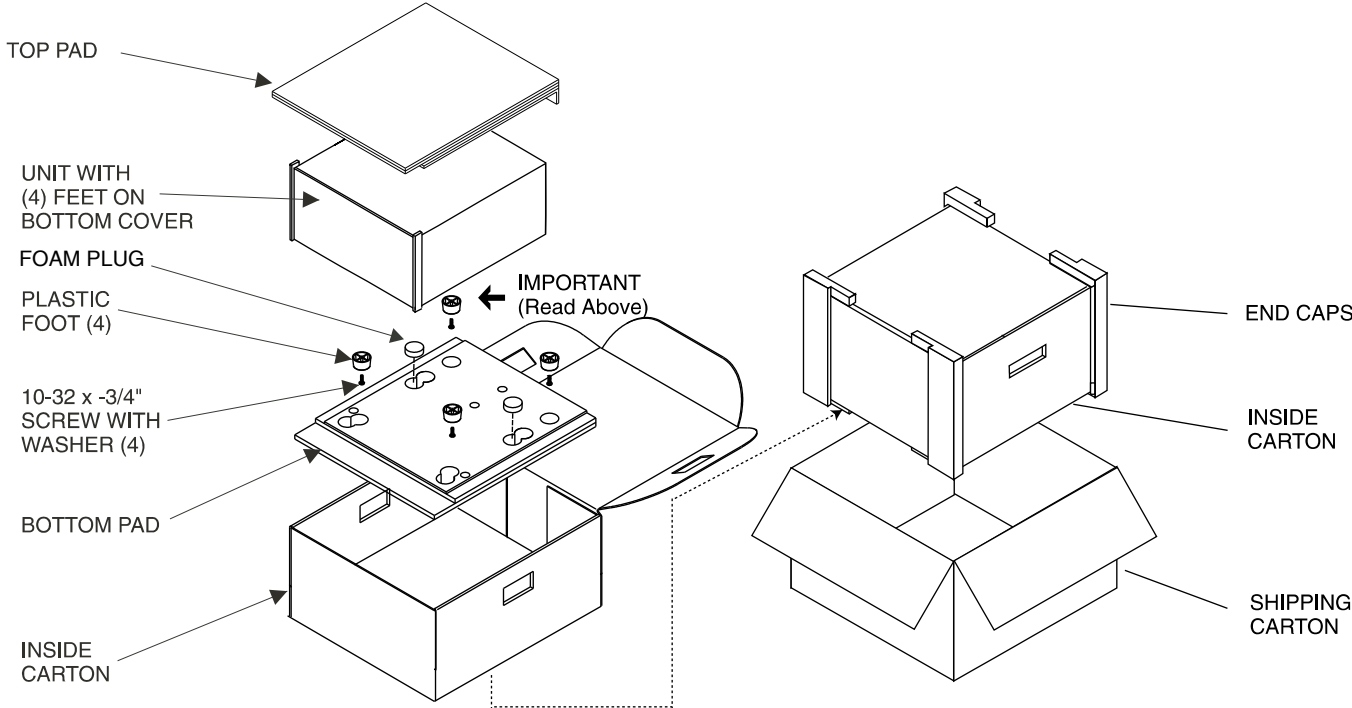



McIntosh Laboratory, Inc.
2 Chambers Street
Binghamton, NY 13903
www.mcintoshlabs.com

The continuous improvement of its products is the policy of McIntosh Laboratory Incorporated who reserve the right to improve design without notice.
Printed in the U.S.A.