

McIntosh  
MA 6200

# OWNER'S MANUAL

THE MA 6200 INTEGRATED AMPLIFIER



Reading Time: 40 Minutes

Price: \$2.00

Your MA 6200 Integrated Amplifier will give you many years of pleasant and satisfactory performance. If you have any questions, please contact:

### CUSTOMER SERVICE

McIntosh Laboratory Inc.  
2 Chambers Street  
Binghamton, New York 13903-9990  
Phone: 607-723-3512

**Take Advantage of 3 years  
of Contract Service . . .  
Fill in the Application NOW.**

# Contents

HOW TO INSTALL . . .	2
HOW TO CONNECT . . .	4
THE FRONT PANEL CONTROLS AND HOW TO USE THEM . . .	8
PERFORMANCE LIMITS . . .	12
PERFORMANCE CHARTS . . .	13,14
TECHNICAL DESCRIPTION . . .	15
BLOCK DIAGRAM . . .	17

## McINTOSH THREE YEAR SERVICE CONTRACT

An application for A THREE YEAR SERVICE CONTRACT is included with this manual.

The terms of the contract are:

1. McIntosh will provide all parts, materials and labor needed to return the measured performance of the instrument to the original performance limits. The SERVICE CONTRACT does not cover any shipping costs to and from the authorized service agency or the factory.
2. Any McIntosh authorized service agency will repair McIntosh instruments at normal service rates. To receive service under the terms of the SERVICE CONTRACT, the SERVICE CONTRACT CERTIFICATE must be presented when the instrument is taken to the service agency.
3. Always have service done by a McIntosh authorized service agency. If the instrument is modified or damaged as a result of unauthorized repair, the SERVICE

CONTRACT will be cancelled. Damage by improper use or mishandling is not covered by the SERVICE CONTRACT.

4. The SERVICE CONTRACT is issued to you as the original purchaser. To protect you from misrepresentation, this contract cannot be transferred to a second owner.
5. To receive the SERVICE CONTRACT, your purchase must be made from a McIntosh franchised dealer.
6. Your completely filled in application for SERVICE CONTRACT must be postmarked within 30 days of the date of purchase of the instrument.
7. To receive the SERVICE CONTRACT, all information on the application must be filled in. The SERVICE CONTRACT will be issued when the completely filled in application is received by McIntosh Laboratory Inc. in Binghamton, New York.





The PANLOC system of installing equipment conveniently and securely is a product of McIntosh research. By depressing the two PANLOC buttons on the front panel, the instrument slide can be locked firmly in place or it can be unlocked so that the chassis can slide forward, giving you easy access to the top and rear panels.

The trouble-free life of an electronic instrument is greatly extended by providing sufficient ventilation to prevent the buildup of high internal temperatures that cause deterioration. Allow enough clearance so that cool air can enter at the bottom of the cabinet and be vented from the top. With adequate ventilation the instrument can be mounted in any position.

The recommended minimum space for installation is 15 inches (38.1 cm) deep, 17 inches (43.2 cm) wide, and 6 inches (15.2 cm) high.

To install the instrument in a McIntosh cabinet, follow the instructions that are enclosed with the cabinet. For any other type of installation follow these instructions:

1. Open the carton and remove the PANLOC brackets, hardware package, and mounting template from the carton. Remove the MA 6200 from its plastic bag and place it upside down on the shipping pallet; unscrew the four plastic feet from the bottom of the chassis.

2. Mark the cabinet panel.

Place the mounting template in the position on the cabinet panel where the instrument is to be installed, and tape it in place. The broken lines that represent the outline of the rectangular cutout also represent the outside dimensions of the chassis. Make sure these lines clear shelves, partitions, or any equipment. With the template in place, first mark the six A and B holes and the four small holes that locate the corners of the cutout. Then, join the four corner markings with pencil lines, using the edge of the template as a straightedge.

3. Drill Holes

Use a drill with a 3/16 inch bit held perpendicular to the panel and drill the six A and B holes. Then, using a drill bit slightly wider than the tip of your saw blade, drill one hole at each of two diagonally opposite corners. The holes should barely touch the inside edge of the penciled outline. **Before taking the next step, make sure that the six A and B holes have been drilled.**

4. Saw the Panel Cutout

Saw carefully on the inside of the penciled lines. First make the two long cuts and then the two short cuts. After the rectangular opening has been cut out, use a file to square the corners and smooth any irregularities in the cut edges.

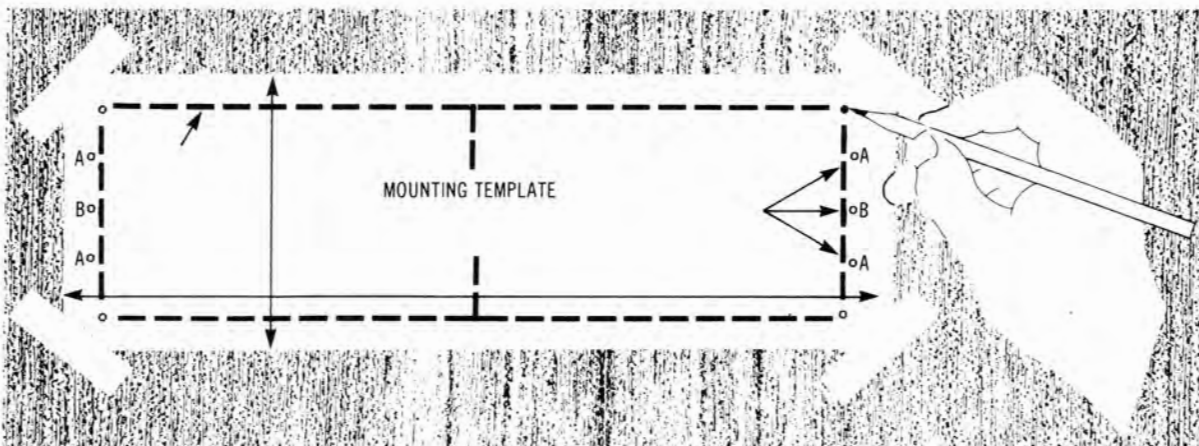

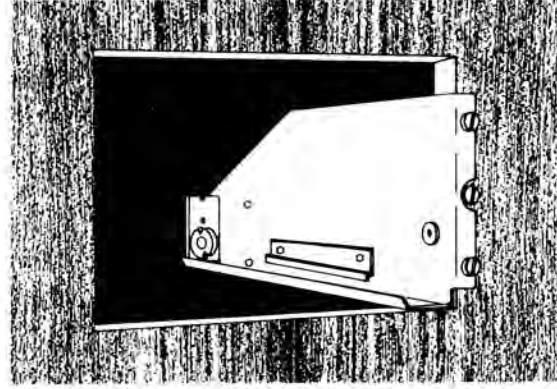
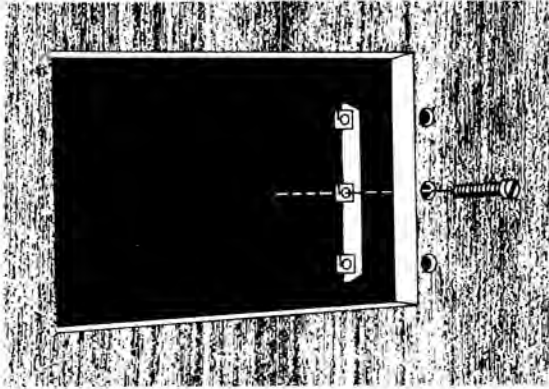

#### 5. Install Mounting Strips

In the hardware package you will find two mounting strips and two sets of machine screws. For panels that are less than  $\frac{1}{2}$  inch thick, use the  $\frac{3}{4}$  inch screws; for panels that are more than  $\frac{1}{2}$  inch thick, use the  $1\frac{1}{4}$  inch screws.

Starting at the right-hand side of the panel, insert a screw of the proper length into the center hole in the panel, marked B on the template. On the back of the panel, align a mounting strip with the holes in the panel and tighten the screw until the screwhead is pulled into the wood.

Repeat this procedure to attach the mounting strip to the left side of the panel.

#### 6. Attach PANLOC Brackets

Using two screws of the proper length in the A holes on each side, attach the PANLOC brackets to the cabinet panel; the short flange is mounted against the front (face) of the cabinet panel. The screws pass through the PANLOC bracket flange, the cabinet panel, and then through the mounting strips previously mounted.

#### 7. Install the Instrument

Guide the AC power cord through the panel opening to the back of the cabinet; then, slide the instrument into the opening carefully so that the rails on the bottom of each side of the chassis engage the tracks on the mounting brackets. Continue to slide the instrument into the cabinet until it is stopped by the adjust position latches. Press the latches inward, this permits the instrument to slide into the cabinet until its front panel is flush with the cabinet panel. Depress the PANLOC buttons at the lower left and right corners of the instrument panel to lock the unit firmly in the cabinet. Depressing the PANLOC buttons again will unlock the instrument so that it can slide forward to the adjust position; if you press inward on the adjust position latches then you can remove the instrument from the cabinet.



# How to Connect



## CONNECTING TURNTABLE TO PHONO 1 AND 2

Connect the cable from the "left" channel of the turntable into the L PHONO 1 INPUT jack. Connect the "right" channel into the R PHONO 1 INPUT jack.

Connect a second turntable in the same manner to the PHONO 2 INPUT jacks. Shorting plugs are shipped in the PHONO 2 INPUT jacks to eliminate noise if a second turntable is not used. Remove these shorting plugs when connecting the second turntable. Keep them for possible future use. **DO NOT** plug the shorting plugs into an output jack as this may prevent operation of the MA 6200.

## GROUND CONNECTION

A single ground post is provided. Grounds for turntables, record changers, tape decks, etc. are to be connected to this post. The left and right program cables and the ground wire from that source should be wound or twisted together. To avoid hum make sure the ground wire does not make any connections to the shields of the left and right program cables between the program source and the MA 6200.

## CONNECTING A STEREO TUNER AND AUX 1 AND 2

Connect the cable from the "left" channel tuner output to the L TUNER INPUT jack.

Connect the cable from the "right" channel tuner output to the R TUNER INPUT jack

**AUX**—Any high level program source such as a tuner, a TV set or a tape recorder can be connected to the AUX 1 and 2 INPUT jacks. The connecting procedure is the same as for the tuner input.

## CONNECTING TAPE RECORDERS

To Record:

Connect a cable from the L TAPE 1 OUTPUT jack to the left high level input of the tape recorder. Connect a cable from the R TAPE 1 OUTPUT jack to the right high level input of the tape recorder.

Connect a second recorder in the same manner to the TAPE 2 OUTPUT jacks.

To Playback/Monitor:

Connect a cable from the left channel output of a tape recorder to the L TAPE 1 INPUT jack. Connect a cable from the right channel output of a tape recorder to the R TAPE 1 INPUT jack.

Connect a second recorder in the same manner to the TAPE 2 INPUT jacks.

## CONNECTING AC POWER

**The MA 6200 AC power cord is to be plugged into a 120 volt 50/60 Hz wall outlet.**

There are two types of AC power outlets on the back panel of the MA 6200; three black, and two green.

The green AC power outlets are on at all times. Plug the AC power cables from the turntable into the green TURNTABLE power outlets on the rear panel.

The three black outlets are switched on and off when the amplifier is turned on or off. These are intended for equalizers and other accessories.

The POWER ON pushbutton shares AC power control, with the AC power switch on a turntable, through a current detecting switch circuit. On the rear panel the TURNTABLE AUTO/MANUAL switch selects the mode of operation.

When the switch is in the AUTO position and a turntable plugged into one of the green AC power outlets, the AC power to the receiver and to the black AC power outlets can be controlled by the

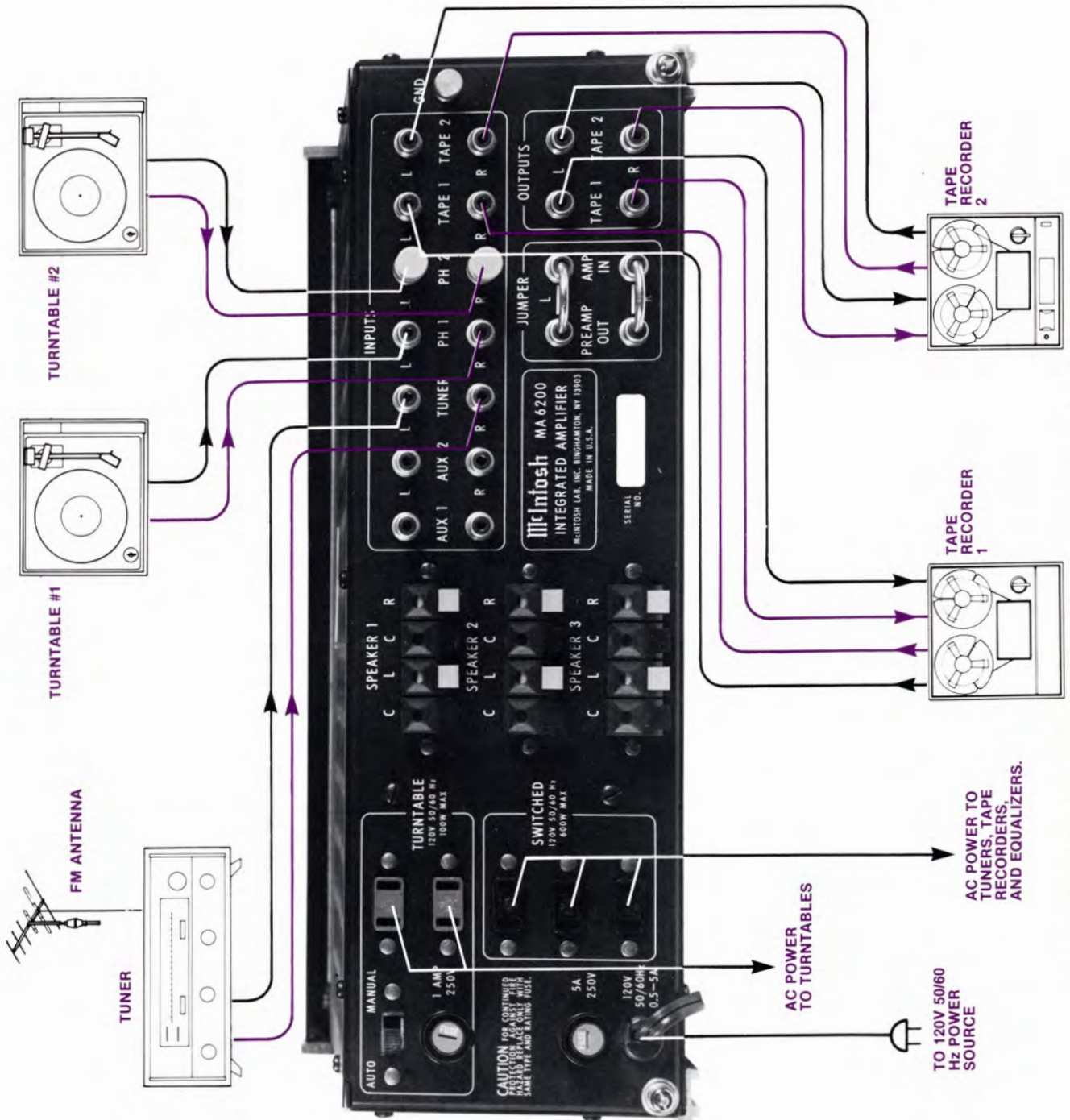

CONNECTIONS FOR TUNERS, TURNTABLES, AND TAPE RECORDERS



turntable on/off switch. When AC power to the turntable is turned on, automatically the instrument and the SWITCHED black AC power outlets are turned on. The system will remain on until the turntable is turned off. The POWER ON pushbutton controls the AC power for any source other than the turntable.

In the MANUAL position only the POWER ON pushbutton will turn AC power on or off.

Some turntables have electronic circuits that draw current all the time. To use these turntables the AUTO/MANUAL switch must be in the MANUAL position. With the AUTO/MANUAL switch in the MANUAL position, AC power to the system will be controlled by the front panel POWER pushbutton only.

### FUSES

A 5-amp fuse protects the MA 6200 circuits. The fuse does not protect additional equipment connected to the rear panel AC power outlets. A one amp fuse protects the turntable auto on circuit. If this fuse fails, power to the green outlets will be interrupted.

### CONNECTING LOUSPEAKERS FOR STEREO

All speakers are connected to the push connectors on the rear panel. When stereo speakers have been connected to the proper push connectors, the corresponding front panel pushbuttons turn the speakers on or off.

Selection of the proper gauge wire to connect the loudspeakers preserves the quality of sound reproduction for which the loudspeakers have been designed. If undersize wire is used, resistance is added to the amplifier/loudspeaker combination which adversely affects the performance. Added resistance causes reduction of damping characteristics, modification of frequency response and reduction in power output.

Use lamp cord, bell wire, or wire with similar type of insulation to connect the speakers to the amplifier. In all cases, the leads to and from the speaker should be twin conductor or twisted together. When using 8 ohm speakers and for the normally short distances of under 30 feet between the amplifier and speaker, No. 18 wire or larger can be used. For distances over 30 feet between the amplifier and speaker use larger diameter wire. Select the correct size wire for the wire length from the chart. It is recommended that the DC resistance of the speaker leads be less than 5% of the speaker impedance. Up to 10% can be tolerated. Resistance of the leads should be computed for the length of wire both to and from the speaker or speakers.

For multiple speaker operation, run separate leads from the amplifier to the speakers.

Connect the leads from the left main loudspeaker to the SPEAKER 1 Left and Common push connectors. Connect the lead from the right main loudspeaker to the SPEAKER 1 Right and Common push connectors. Connect the leads from a second left loudspeaker to the SPEAKER 2 Left and Common push connectors. Connect the lead from a second right loudspeaker to the SPEAKER 2 Right and Common push connectors. Connect the leads from a third left loudspeaker to the SPEAKER 3 Left and Common push connectors. Connect the lead from a third right loudspeaker to the SPEAKER 3 Right and Common push connectors.

The push connector on the MA 6200 will accept up to 16 gauge wire. When larger wire is used it will be necessary to splice a short length of 16 gauge wire to the ends of the heavier wire to make connections. A similar arrangement may be required to connect at the speakers.

### MAXIMUM WIRE LENGTHS

Wire Gauge	For 4 Ohm Load		For 8 Ohm Load	
	Feet	Meters	Feet	Meters
22	6	1.8	12	3.7
20	10	3.1	20	6.1
18	15	4.6	30	9.1
16	25	7.6	50	15.2
14	40	12.2	80	24.4
12	60	18.3	120	36.6
10	100	30.5	200	66.0

Wire lengths above represent the wire resistance equal to 5% of the speaker impedance.

### CONNECTING ONE LOUSPEAKER FOR MONO

The left and right outputs of the MAC 6200 must connect to separate loudspeakers. Do not parallel the output connections for a single loudspeaker. If the left and right outputs are connected together excessive heat is generated in the power amplifiers which causes damage even though the MODE SELECTOR pushbutton is in the MONO position. If you wish to drive a single loudspeaker, put the MODE SELECTOR in MONO and connect the loudspeaker to the left or the right speaker push connectors only. It is not necessary to connect a load to the other channel output.

### CONNECTING A McINTOSH EQUALIZER

On the JUMPER panel, remove the jumpers between the PREAMP OUT jacks and power AMP Input jacks. The environmental equalizer is connected between these jacks. Use standard shielded cables. Connect the PREAMP OUT to the input of the equalizer. Connect the output of the equalizer to the power AMP Input jack.

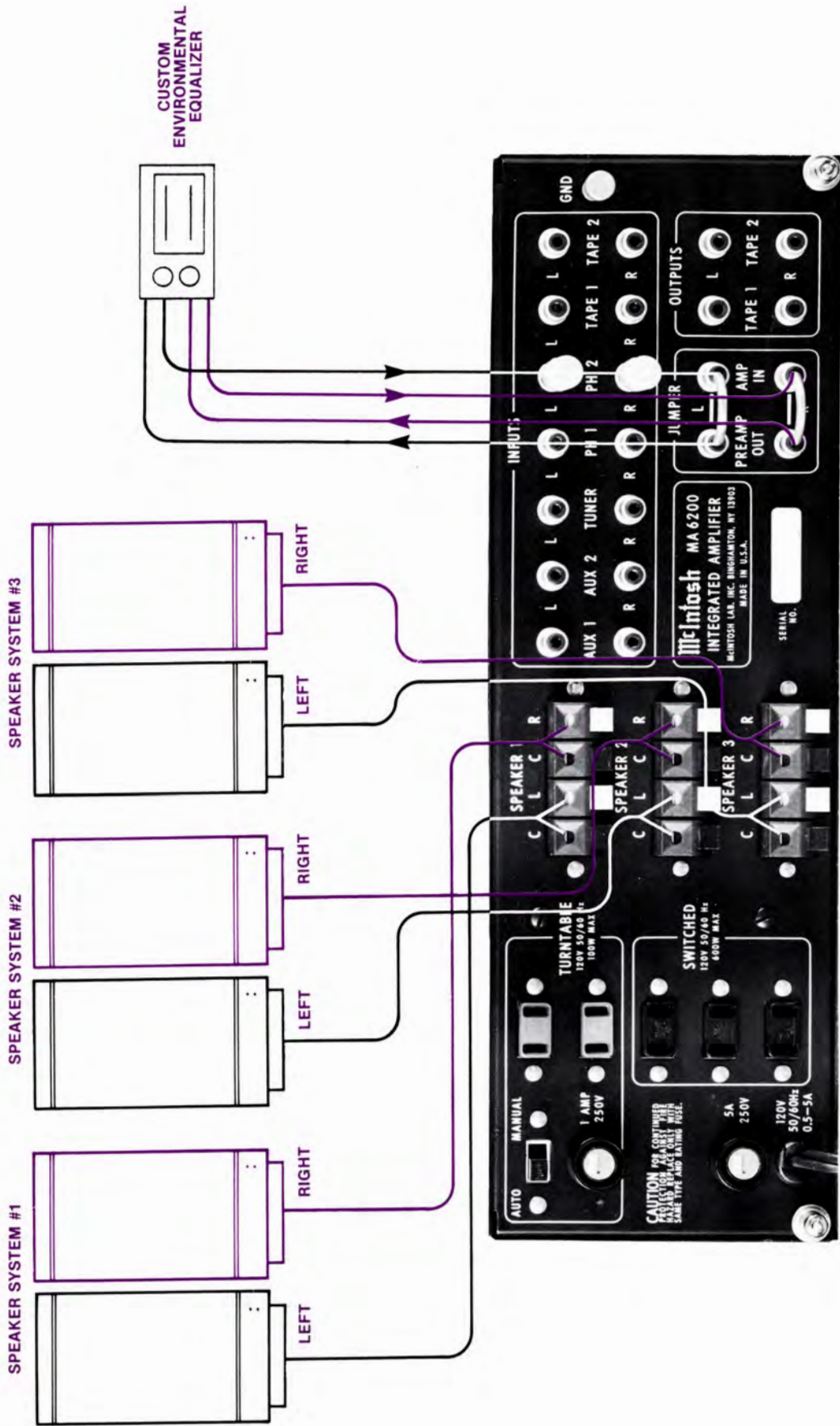

CONNECTIONS FOR ENVIRONMENTAL EQUALIZER AND LOUDSPEAKERS





# The Front Panel Controls and How to Use Them

## INPUT SELECTOR

The INPUT SELECTOR is a five position switch that connects the chosen input program to the proper circuits in the MA 6200.

AUX 1: Connects to the high level input, any output from a high level program source requiring flat amplification. Such a source could be a television set, playback from another tape recorder, an additional tuner, etc.

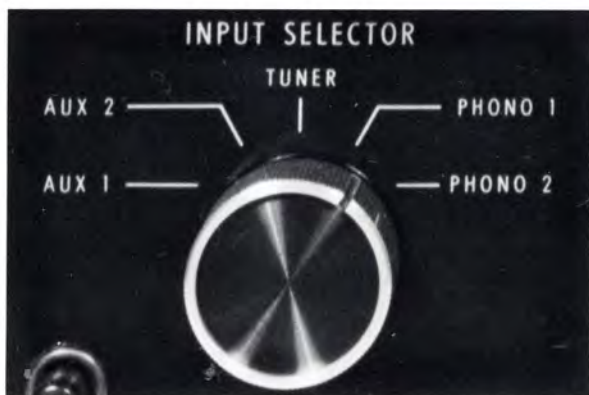

AUX 2: Same as AUX 1 but for a second high level program source.

TUNER: Connects the output from any AM, FM or MPX FM tuner to the high level input stage. In the TUNER position the MA 6200 has flat amplification.

PHONO 1: Connects the output of any magnetic phono cartridge to the low level input stage. The

response has been shaped according to the RIAA standard to compensate for the characteristics of a magnetic phono cartridge.

PHONO 2: Same as PHONO 1 but for a second phono system.

## MODE SELECTOR

The MODE SELECTOR facilitates the accurate adjustment of a stereo system for some differences caused by room acoustics, loudspeaker placement and the other components used in the system.

The MODE SELECTOR switch connects the program to the loudspeaker in seven ways:

L to L and R: Connects the left program to both loudspeakers.

R to L and R: Connects the right program to both loudspeakers.

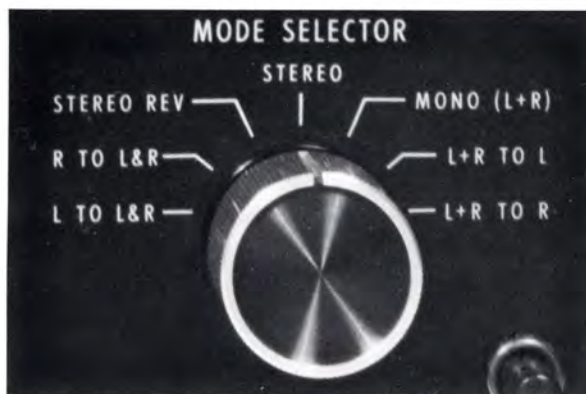

**STEREO REV:** Connects the left program to the right loudspeaker and the right program to the left loudspeaker.

**STEREO:** Connects the left program to the left loudspeaker and the right program to the right loudspeaker.

**MONO (L + R):** Adds the left and right programs together and connects to both loudspeakers.

**L + R to L:** Connects the left plus right program to the left loudspeaker only.

**L + R to R:** Connects the left plus right program to the right loudspeaker only.



#### VOLUME CONTROL

The **VOLUME** control is a precision step control manufactured for McIntosh Laboratory. It has 32 steps with a 70 dB range, plus volume off. Left and right channel tracking are within

1 dB. This extreme accuracy is obtained through special electronically controlled resistance element trimming.



#### BALANCE and LOUDNESS CONTROLS

The **BALANCE** and **LOUDNESS** controls are concentric. The **BALANCE** control [large outer knob] adjusts for equal volume of either the left or right channels. The volume of the channels can be varied relative to each other.

left . . . turning the control to the left accents the left channel by reducing the right channel output.

right . . . turning the control to the right accents the right channel by reducing the left channel output.

left . . . turning the control to the left accents the left channel by reducing the right channel output.

The **LOUDNESS** control [small center knob] increases both bass and treble frequencies of both channels as it is turned clockwise. Adjustment of the **LOUDNESS** control allows life-like frequency balance when playing music softly. Its frequency response contour is accurately modeled after the family of "Equal Loudness" curves identified by Fletcher and Munson.

The loudness circuitry is completely independent of the volume control. Therefore, any desired amount of compensation can be introduced regardless of volume control position.

Frequency response is flat and there is no loudness compensation when the knob is turned fully counter-clockwise to the "flat" position.

#### EQUALIZER FREQUENCY CONTROLS

Each of five **EQUALIZER FREQUENCY** controls modifies upward or downward the tone balance of a band of frequencies centered on the frequency marked above the control. The flat position of the control has a detent for easy reference. Each control provides 12 dB boost or cut at the specified center frequency.



Use the **EQUALIZER FREQUENCY** controls to modify the sound and tone balance of program material. Here are some suggestions from which to start:

Problem	Equalizer Correction
Bass too weak	Raise 30 and/or 150
Male vocalist needs reinforcing	Raise 150
Female vocalist reinforcing	Raise 500
Hum on program	Reduce 30
Violins, trumpets dull	Raise 1500
Drum "brushes" not audible	Raise 10K

#### HEADPHONE JACKS

The front panel **HEADPHONE** jacks have been designed to feed low impedance dynamic headphones. Electrostatic headphones generally require higher power than dynamic headphones. They must be connected to the speaker push connectors on the rear panel.

Plug headphones into either front panel **HEADPHONE** jack. Adjust the front panel **VOLUME** control for comfortable headphone listening.

Signal to the headphone jacks is not affected by the **SPEAKER** switches.

#### TAPE PUSHBUTTONS

**IMPORTANT:** When the MA 6200 is operated with either **MONITOR** pushbutton at the in position, the program heard will be that from the tape recorders only. Signal from any other source will not be heard from the loudspeakers. To hear any other source, make sure the **MONITOR** pushbuttons are **OUT**.

The **MONITOR** switches are mechanically interlocked to prevent simultaneous monitoring from two tape recorders. If one button is at the in position, it must be pushed again to release it to the out position before the other button can be pushed.





The MA 6200 is designed so it may be used with two tape recorders. The four left pushbuttons control the signal output of these recorders. They permit recordings to be monitored as they are being recorded, or copying of tapes from one recorder to another while listening to a separate program or the playback of either recorder.

**MONITOR TAPE 1** pushbutton out: The program source as selected by the INPUT SELECTOR is fed to the power amplifiers and heard through the loudspeakers; pushbutton in: Signal from a tape recorder plugged into INPUTS TAPE 1 is fed to the power amplifiers and heard through the loudspeakers.

**MONITOR TAPE 2** Pushbutton: Functions similarly to monitor Tape 1. It also controls the program from a tape recorder plugged into the front panel TAPE jacks. When a tape recorder is plugged into the front jacks the tape input circuit is transferred from the rear TAPE 2 IN jack to the front jack. The tape recorder plugged into the TAPE 2 IN jack on the rear panel is automatically disconnected.

**TAPE COPY T1-T2** pushbutton in: connects the output from tape recorder 1 to the input of tape recorder 2 without affecting the program being heard from the speakers. In this position a copy of the program on tape recorder 1 can be made on tape recorder 2. To monitor the original use MONITOR TAPE 1 pushbutton and to monitor the copy use MONITOR TAPE 2 pushbutton.

**TAPE COPY T2-T1** pushbutton in: connects the output from tape recorder 2 to the input of tape recorder 1 without affecting the program being heard from the speakers. In this position a copy of the program on recorder 2 can be made on recorder 1. To monitor the original use MONITOR TAPE 2 pushbutton and to monitor the copy use MONITOR TAPE 1 pushbutton.

#### TAPE RECORDER FRONT PANEL CONNECTION

Input and output facilities are available at the TAPE IN-OUT jacks on the front panel. These front panel jacks make connections without having to get at the rear panel. When using the front panel jacks, the rear TAPE 2 IN jack is automatically disconnected.

A metal shielded 1/4 inch stereo phone plug is used for best shielding. Connections follow the industry standards and are tip: left signal, ring: right signal, and sleeve: common ground.

#### SPEAKERS 1, 2 and 3 PUSHBUTTONS

When each of these pushbuttons is pushed in, a pair of loudspeakers is connected to the power amplifier outputs. Speaker 1, 2 and 3 may be selected one at a time, any combination or all at once.

#### POWER ON PUSHBUTTON

The POWER ON pushbutton shares AC power control, through a current detecting switch circuit, with the AC power switch on a turntable. On the rear panel the TURNTABLE AUTO/MANUAL switch selects the mode of operation.

When the switch is in the AUTO position and a turntable is plugged into one of the green AC power outlets the AC power to the MA 6200 and to the black AC power outlets can be controlled by the turntable on/off switch. When AC power to the turntable is turned on, automatically the MA 6200 and the SWITCHED black AC power outlets are turned on. The system will remain on until the turntable is turned off. The POWER ON pushbutton switch parallels the automatic turntable power control feature. The POWER ON pushbutton is used to turn on and off power when the turntable is not used. The POWER ON pushbutton must be out or off for the turntable to control the AC power.

In the MANUAL position only the POWER ON pushbutton will turn the MA 6200 and black outlet AC power on and off.

#### POWER GUARD INDICATOR LAMPS

POWER GUARD assures that the power amplifier section of the MA 6200 can not be over driven, thus amplifier output clipping is eliminated. Clipping is caused when the amplifier is asked to produce more power output than it can deliver with low distortion. Amplifiers are capable of delivering large quantities

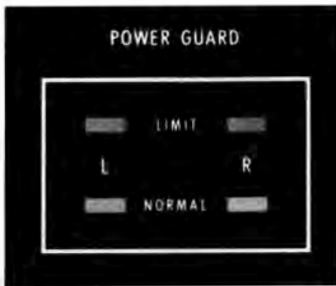

of power when they are driven to clipping and can have more than 40% harmonic distortion. The extra energy content of the clipped signal will damage most speakers. A McIntosh advancement helps to protect your speaker

from this kind of damage. The MA 6200 has a built in "waveform comparator" that compares the wave shape of the input signal with the output signal. If the non-linearity between the two signals exceeds 0.5% the POWER GUARD circuit operates. Operation is indicated when the red limit indicators turn on. As long as the amplifier operates without overload the normal indicator illuminates.

#### **PUSHBUTTON INDICATOR LAMPS**

These are eight red indicator lamps above the pushbutton switches. They indicate the function selected by the corresponding pushbutton. These indicators are also connected to an internal thermal overload protector circuit. In the event of high internal temperatures these indicators will extinguish and output power will be disconnected from the loudspeaker. When the unit cools normal operation will be restored.



# Performance Limits

We promise you that the MA 6200 you buy must be capable of performance at or exceeding these limits at the time of purchase or you get your money back. McIntosh PERFORMANCE LIMITS are the maximum departure from perfection permitted for a McIntosh instrument.

## PERFORMANCE

McIntosh audio power ratings are in accordance with the Federal Trade Commission Regulation of November 4, 1974 concerning power output claims for amplifiers used in home entertainment products.

## POWER OUTPUT

100 Watts minimum sine wave continuous average power output per channel, both channels operating into 4 ohms, 20 Hz to 20 kHz, with no more than .05% total Harmonic Distortion.

75 Watts minimum sine wave continuous average power output per channel, both channels operating into 8 ohms, 20 Hz to 20 kHz, with no more than .05% total Harmonic Distortion.

## OUTPUT LOAD IMPEDANCE

4 ohms, 8 ohms.

## RATED POWER BAND

20 Hz to 20 kHz

## TOTAL HARMONIC DISTORTION

.05% maximum at any power level from 250 milliwatts to rated power per channel, 20Hz to 20kHz, both channels operating.

## INTERMODULATION DISTORTION

.05% maximum at any power level from 250 milliwatts to rated power per channel with both channels operating for any combination of frequencies 20 Hz to 20 kHz.

## FREQUENCY RESPONSE

20 Hz to 20 kHz +0, -0.5 dB at rated power

## HUM AND NOISE

**Power Amp:** 105 dBA, 100 dB unweighted, below rated output

**Tape & Aux Input:** 100 dBA, 95 dB unweighted, below rated output

**Phono Input:** 85 dBA, 80 dB unweighted, below 10 mV input

## DAMPING FACTOR

Greater than 30

## INPUT SENSITIVITY AND IMPEDANCE

**Power Amp:** 2.5 Volts 22,000 ohms

**Tape & Aux:** 250 mV 100,000 ohms

**Phono:** 2 mV 47,000 ohms, 100pf

## TAPE OUTPUT

**Aux, Tape:** 250 mV with rated input

**Phono:** 250 mV with rated input

## PROGRAM EQUALIZER

± 12 dB at 30, 150, 500, 1,500, and 10,000 Hz

## POWER REQUIREMENT

120 Volts, 50/60 Hz, 0.5 to 4 amps (50 to 400 watts).

## SEMICONDUCTOR COMPLEMENT

42 Transistors

13 Integrated Circuits

25 Diodes

1 Silicon Controlled Rectifier

## MECHANICAL INFORMATION

**SIZE:** Front Panel measures 16 inches wide (40.6 cm) by 5 7/16 inches high (13.8 cm). Chassis measures 14 3/4 inches wide (37.5 cm) by 4 13/16 inches high (12.2 cm) by 13 inches deep (33.0 cm), including PANLOC shelf and back panel connectors. Knob clearance required is 1 1/4 inches (3.2 cm) in front of the mounting panel.

**FINISH:** Front panel is anodized gold and black with special gold/teal nomenclature illumination. Chassis is black.

**MOUNTING:** Exclusive McIntosh developed professional PANLOC

**WEIGHT:** 30 pounds (13.6 kg) net. 42 pounds (19.1 kg) in shipping carton

# Performance Charts

POWER OUTPUT SECTION  
HARMONIC DISTORTION VS POWER  
RL = 8 OHMS, BOTH CHANNELS OPERATING

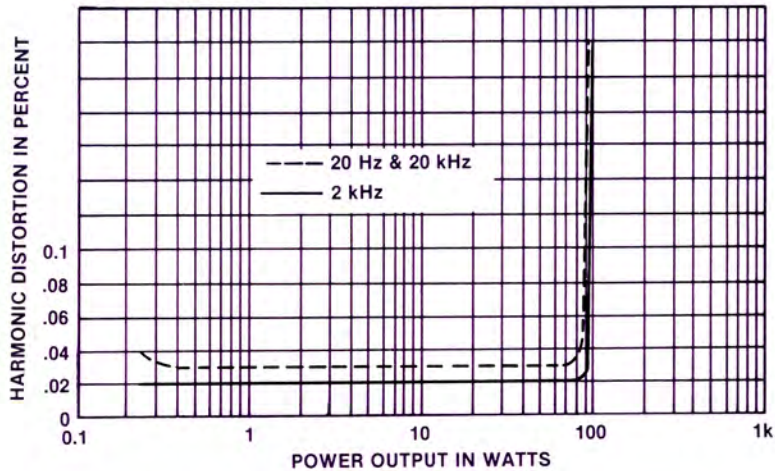

POWER OUTPUT SECTION  
BOTH CHANNELS OPERATING  
.05% THD POWER BANDWIDTH

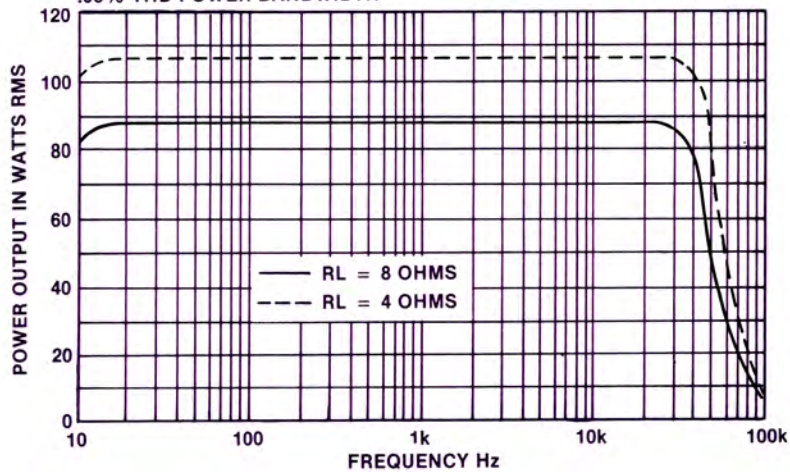

INTERMODULATION DISTORTION  
vs.  
POWER OUTPUT  
8 OHM OUTPUT  
INPUT FREQUENCIES 60 Hz AND 7 kHz  
INPUT RATIO: 4.1

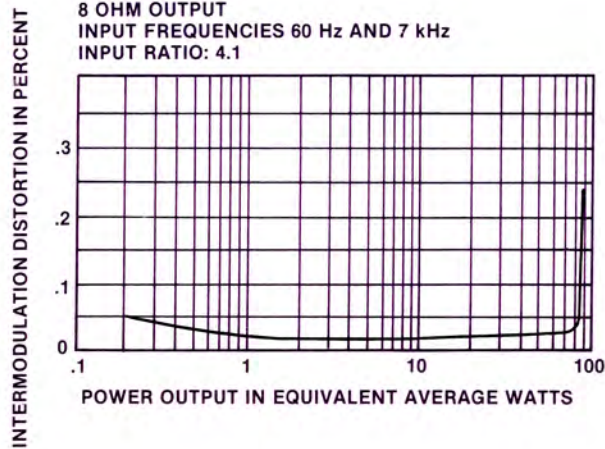

OUTPUT SIGNAL WAVEFORM SHOWING ACTION  
OF POWER GUARD TO ELIMINATE OUTPUT SIGNAL  
CLIPPING. AMPLIFIER INPUT IS OVERDRIVEN BY  
20 dB FOR BOTH OSCILLOGRAM TRACES.

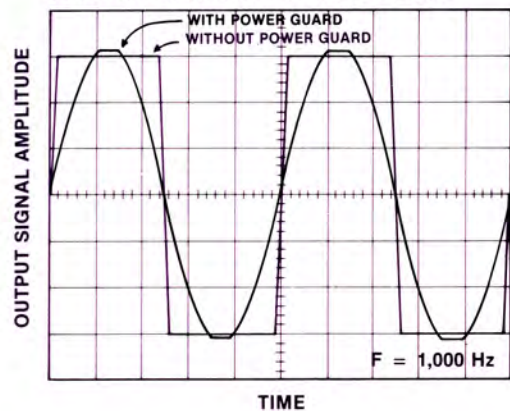



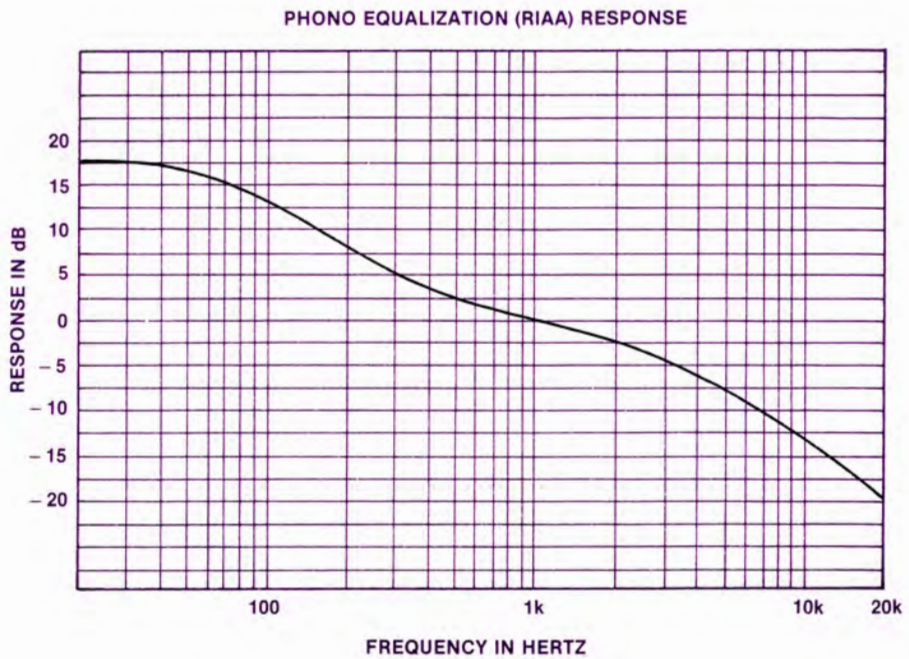
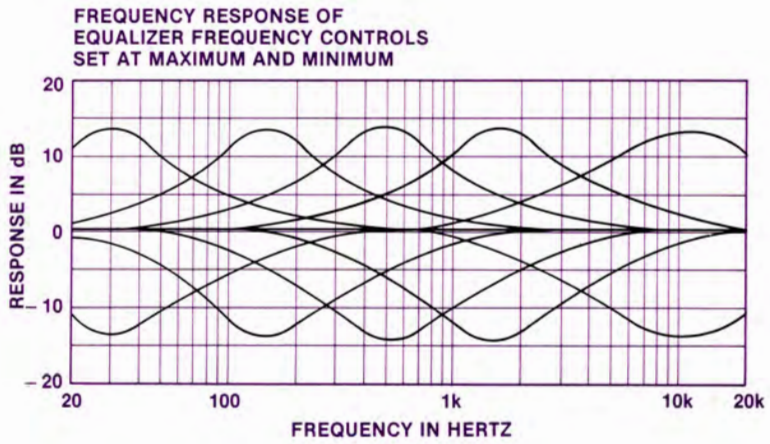
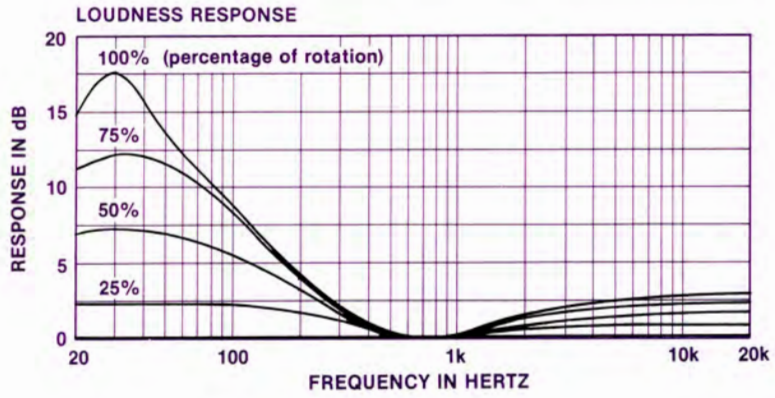

# Technical Description

## AUDIO SECTION

Each channel of the MA 6200 has four basic sections. They are: phono preamplifier, high level and loudness amplifier, equalizer amplifier, and power amplifier.

## PHONO PREAMPLIFIER

The phono preamplifier uses a high technology integrated circuit operational amplifier. Its differential input stage has been optimized for low noise and low distortion performance. Open loop gain of this integrated circuit is 100,000. With high open loop gain a large amount of negative feedback can be used around the phono preamplifier to further reduce noise and distortion. The feedback network also provides precision RIAA frequency compensation. The network uses 1% metal film resistors and 5% poly film capacitors. To achieve low noise performance it is essential that the feedback network be very low impedance. As a consequence, the preamplifier must be capable of operating as a power amplifier to drive this impedance. The actual power output capability of this preamplifier stage is more than 100 milliwatts, a great margin beyond that which is required.

Input sensitivity of the phono preamplifier is 2 millivolts. The gain of the amplifier is 42 dB at 1000 Hz. The phono preamplifier has a very wide dynamic range. At 1000 Hz the phono input circuit will accept 100 millivolts without overload, a voltage far greater than the output of any current magnetic phono cartridge. Phono input overload therefore is virtually impossible. A signal level of 10 millivolts at the phono input at 1000 Hz will produce 1.2 volts at the tape output. The tape output has a source impedance of 200 ohms. For most efficient signal transfer the tape output should operate into a load impedance of 5,000 ohms or greater.

## HIGH LEVEL AMPLIFIER

At the input to the high level or loudness amplifier the signal passes through the mode switch, then through the volume control, and into the amplifier. In the past loudness controls have typically used simple passive circuits connected to a tap on the volume control. As a consequence, compensation accuracy was dependent on many variables such as volume control position and differences in input level. The MA 6200 uses active circuitry. The same type of integrated circuit operational amplifier that is used in the phono amplifier is used here. It has two feedback loops. One feedback loop is flat. The other feedback loop conforms to the Fletcher-

Munson equal loudness compensation. A potentiometer is placed between these two feedback loops making it possible to select any combination of the two from a flat response to full loudness compensation. The overall gain of the stage is 20 dB and is not affected by the position of the loudness control at mid frequencies.

## EQUALIZER AMPLIFIER

The equalizer amplifier is constructed with the same operational amplifiers as used in previous amplifiers. Five other operational amplifiers are each arranged in an active circuit configuration that is the equivalent of a series tuned circuit, one at each of the five center frequencies. Each series tuned circuit is inserted, via the equalizer control potentiometer, in either the input circuit or feedback circuit of the equalizer amplifier thereby providing a boost and cut capability of 12 dB for each band of frequencies.

## POWER AMPLIFIER

The input impedance of the power amplifier is 22,000 ohms and requires 2.5 volts rms to drive the amplifier to rated output. The short jumpers on the rear panel of the MA 6200 connect the equalizer amplifier output [PREAMP OUT] and power amplifier input [AMP IN]. At the input of the power amplifier two transistors are connected as a differential amplifier. The two input signals to the differential amplifier are the input signal and the negative feedback signal from the power amplifier. The differential amplifier permits the best use of negative feedback to maintain low noise and low distortion performance. The outputs of the differential amplifier are combined in a current mirror to a single output. The current mirror feeds a linear voltage amplifier which in turn drives two medium power driver transistors. The drive transistors feed the output stages. The output section is arranged as a fully complementary direct coupled series push/pull amplifier. The power transistors used in the output circuit are selected for their high power dissipation capability, wide frequency response, and large safe operating area. The power transistors are mounted on large black anodized heat sinks to assure that under normal operating conditions the transistors will operate at a low temperature. If operating temperatures should increase due to a shorted speaker or restricted ventilation, an automatic sensing device turns the speaker circuit off. The speaker circuit will turn on again when the temperature has returned to its normal limits. This additional protection assures you of reliability even under the most extreme operating



conditions. To further insure reliability a special power output SENTRY MONITORING CIRCUIT prevents failure of the power amplifier transistors due to excessive mismatch or shorting of the output. When the MA 6200 operates normally the SENTRY MONITORING CIRCUIT has no effect on signals passing through the power amplifier. If the power dissipation in the output transistors should rise above normal design limits the SENTRY MONITORING CIRCUIT restricts the drive to the output stage which reduces the dissipation in the output transistors. The SENTRY MONITORING CIRCUIT acts instantaneously for any input signal or load combination. This arrangement assures circuit reliability. Only McIntosh gives you this degree of protection.

The direct coupled complementary amplifier circuit holds the output at DC ground potential when there is no signal input which eliminates the need for a coupling capacitor in the output. The MA 6200 power amplifier is all direct coupled to insure maximum low frequency performance. In most direct coupled circuits, failure of any transistor in the power amplifier will cause a DC potential to appear in the output. To assure that no damaging or interfering DC appears across the output terminals, a special, very fast acting protector circuit constantly monitors the output circuit for DC. If, at any time, a constant DC level appears, the speakers are disconnected. The protective circuit reacts in milliseconds. Speakers remain disconnected until the cause has been fixed. Under normal operating conditions the protective circuit has no effect on the operation of the output circuit. This is another example of McIntosh continuous protection.

#### **POWER GUARD**

Amplifiers are capable of delivering large quantities of power when they are driven to clipping. Clipping is caused when the amplifier is asked to produce more power output than it can deliver with low distortion. A clipped amplifier can have more than 40% harmonic distortion. The extra energy content of the clipped signal will damage most loudspeakers, particularly delicate high frequency tweeters. A new McIntosh advancement helps protect your speakers from this kind of damage. The MA 6200 has a built-in waveform comparator which compares the wave shape of the input signal with the output signal. If the disparity between the two signals exceeds 0.5% [equivalent to 0.5% total harmonic distortion] a red limit indicator illuminates. With any further increase in distortion the POWER GUARD circuit will operate. This circuit limits the input dynamically so that the amplifier cannot be overdriven. POWER GUARD eliminates amplifier output clipping.

POWER GUARD does not limit the dynamic range or the power output of the power amplifier. Clipping

occurs when an amplifier is asked to exceed its design limits and the capacity of the power supply. Since POWER GUARD does not begin to work until this point is reached, the power capability of the amplifier is never affected.

#### **TURN ON DELAY**

The MA 6200 has transient-free turn on and turn off characteristics. A heavy duty relay, time-controlled by a transistor switch, connects the output to the speakers. The control to the transistor switch is derived from a long time constant capacitor charging network that turns the relay on approximately two seconds after the power switch is turned on. The same circuit has a short turnoff time constant and the relay drops out before the amplifier's main power supply has a chance to discharge.

#### **POWER SUPPLY**

Two high current power supplies - a positive 48 volt and a negative 48 volt DC - are used to drive the output power amplifier. Very large filter capacitors, 12,000 microfarads each, are used to store a large amount of energy to provide good filtering and excellent voltage regulation. Good low frequency response and negligible low frequency distortion in the power amplifier stages depends on the regulation of the power supply. Two additional electronically regulated power supplies are used in the MA 6200. A + 18 volt and a - 18 volt line supply all operational amplifiers.





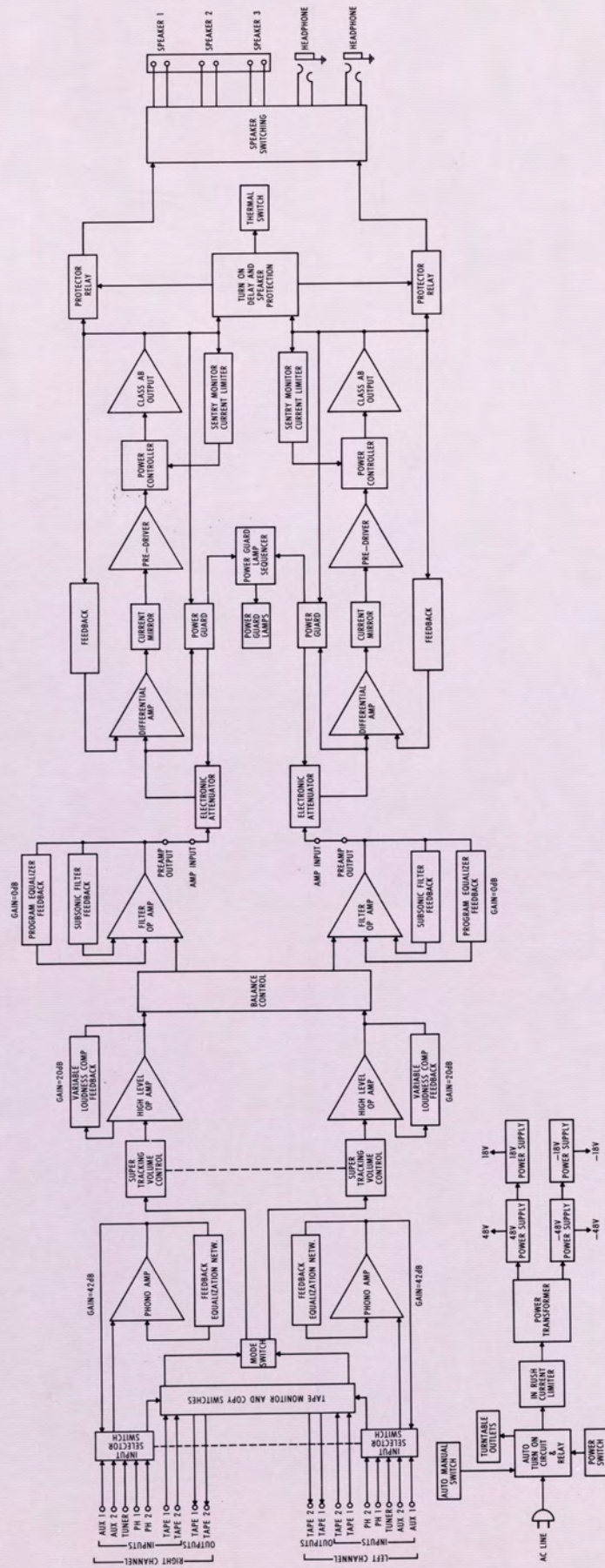

McINTOSH MA 6200 INTEGRATED AMPLIFIER

# Block Diagram



# McIntosh<sup>®</sup>

**McINTOSH LABORATORY INC.  
2 CHAMBERS ST., BINGHAMTON, N.Y. 13903-2699  
607-723-3512**

The continuous improvement of its products is the policy of  
McIntosh Laboratory Incorporated who reserve the right to  
improve design without notice.

Printed in U.S.A.